

Model Series 460

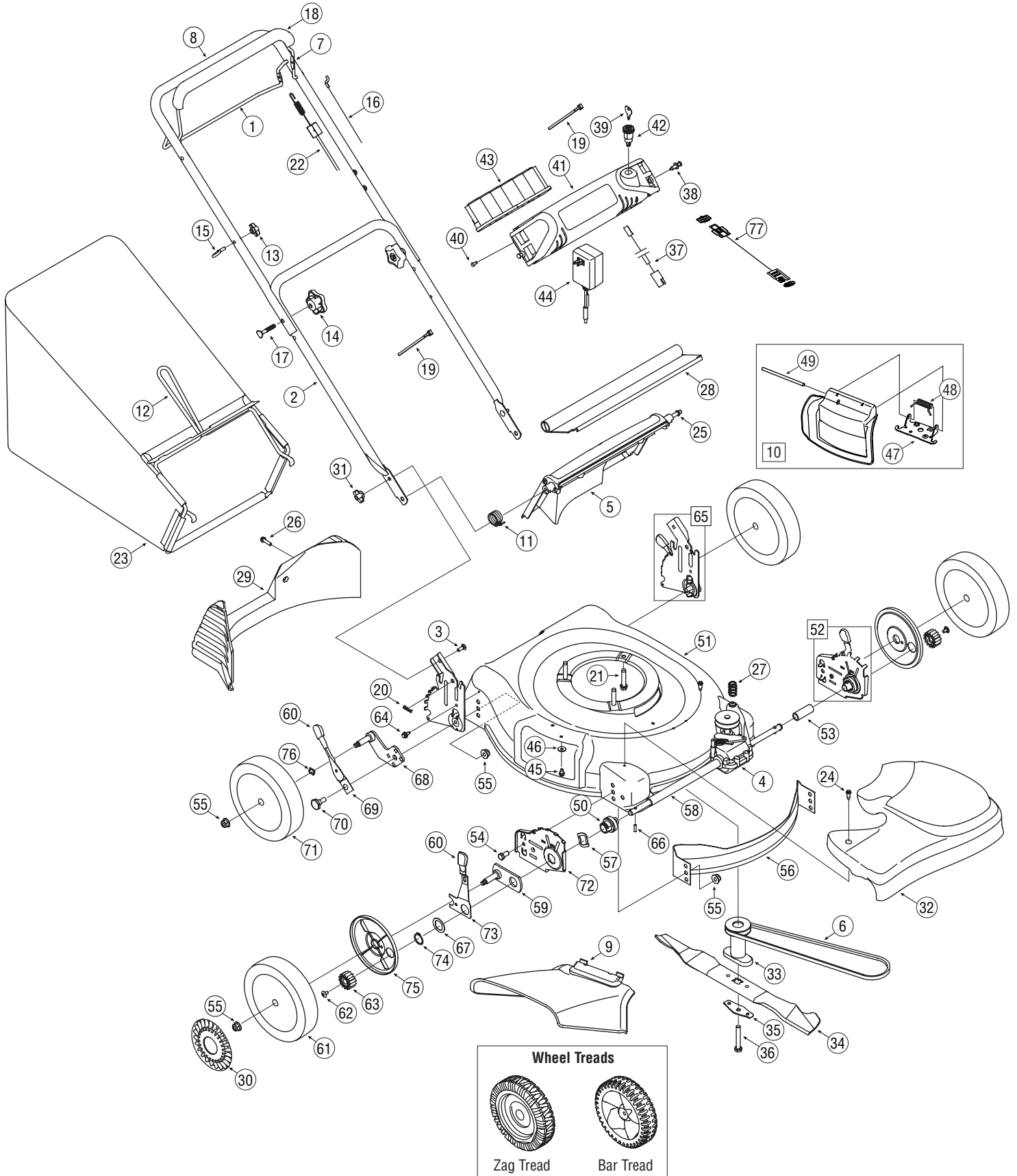

1	747-1214	Drive Control	42	725-04347†	Key Switch
2	749-0928A	Lower Handle	43	725-04323†	12 Volt Battery
3	710-0703	Carriage Bolt 1/4-20	44	725-04329†	Battery Charger
4	617-04376A	Transmission Assembly	45	710-0599	TT Screw 1/4-20 x 0.5
5	731-05865	Rear Discharge Door	46	736-0270	Bell Washer.265 x 0.75
6	754-0637A	V-Belt	47	17032A	Deflector Chute Adapter
7	747-1161A	Blade Control	48	732-1014	Torsion Spring
8	749-1233D	Upper Handle (Electric Start)	49	747-0710	Hinge Pin
	749-1092A	Upper Handle (Non-electric start)	50	682-0015	Bearing Assembly
9	731-04177	Chute Deflector	51	787-01278	21" Deck
10	687-02055	Mulch Plug Complete	52	687-02194	Height Adjustment Ass'y - RH
11	732-04090A	Torsion Spring - RH		687-02193	Height Adjustment Ass'y - LH
12	747-04080	Grass Bag Frame	53	750-04595	Slev. Spacer 1.4" Lg.
13	720-0279	Handle Knob	54	710-0216	Hex Screw, 3/8-16 x.75
14	720-04072	Handle Knob	55	712-04065	Flange Lock Nut, 3/8-16
15	710-1205	Eye Bolt	56	782-5002B	Front Baffle
16	746-1132	Control Cable - 40.75"	57	736-0447	Wave Washer
	746-04309	Control Cable - 39"	58	750-04594	Sleeve Spacer 8.985" Lg.
	746-04135	Control Cable - 39" (Kawasaki)	59	687-02044	Pivot Plate Assembly
17	710-1174	Carriage Bolt 5/16-18 x 2.0	60	720-0426	Adjustment Knob
18	731-04859†	Bail Cover	61	634-0190	Front Wheel, 8 x 1.8, Bar
19	726-0240	Cable Tie		734-2042	Front Wheel, 8 x 2.125, Zag
20	714-0104	Cotter Pin	62	710-04531	Screw, 1/4-20 x .390
21	710-0654A	Self-Tapping Sems Screw	63	717-1762	Gear 14T RH FWD
22	746-04203	Drive Cable		717-1761	Gear 14T LH FWD
23	664-04007A	Grassbag - Black	64	710-1652	TT Scr. w/Washer 1/4-20 x.625
	664-04034A	Grassbag - Gray	65	687-02271	Handle Bracket Assembly - RH
24	710-1650	Shoulder Screw # 12 -24		687-02270	Handle Bracket Assembly - LH
25	747-04587	Pivot Rod	66	715-0221	Dowel Pin
26	710-1241	Screw, 1/4-15 x 1.00	67	736-0474	Washer
27	732-1043	Belt Tension Spring	68	687-02071A	Pivot Arm Assembly - RH
28	731-05642	Rear Trailing Shield		687-02070A	Pivot Arm Assembly - LH
29	731-04150C	Rear Baffle	69	732-04175	Rear Spring Lever
30	731-0981A†	Hub Cap	70	738-0507B	Shoulder Scr., 500 Dia. x. 434
31	712-0397	Wing Nut	71	734-1987	Rear Wheel, 8 x 1.8, Bar
32	731-05013A	Transmission Cover - Black		734-2004A	Rear Wheel, 8 x 2.125, Zag, w/BB
	731-05250	Transmission Cover - Gray		734-2005A	Rear Wheel, 8 x 2.125, Zag
33	748-04015A	Blade Adapter	72	787-01298	Height Adjuster Plate - RH
34	742-0741	21" Mulching Blade		787-01299	Height Adjuster Plate - LH
35	736-0524B	Blade Bell Support	73	732-0706	Front Lever - RH
36	710-1257	Hex Screw 3/8-24 x 2.50		732-0707	Front Lever - LH
37	725-04293†	Electric Starter Harness	74	716-0102	Snap Ring
38	728-0199†	Rivet	75	782-7551A	Wheel Dust Cap
39	725-0201†	Key	76	736-0504†	Washer, Wave, .510 x .750 x .017
40	710-1667A†	Screw, #10-16 x .75	77	725-04310†	Extension Harness (Kawasaki)
41	731-05459†	Battery Housing			

† If Equipped