



Service Kit 753-04517

Date: June 9, 2004

Subject: P/N 738-0919 Steering Shaft
Service Replacement

Models Affected: N/A

PURPOSE: This service kit is the service replacement for Steering Shaft P/N 738-0919.

NOTE: These materials are prepared for use by trained technicians who are experienced in the service and repair of equipment of the kind described in this publication, and are not intended for use by untrained or inexperienced individuals. Such individuals should seek the assistance of an authorized service technician or dealer.

NOTE: Save this Instruction Sheet. Refer to it when ordering replacement parts.

Service Kit Contents (See Figure 1)

ITEM NO.	PART NUMBER	QTY	DESCRIPTION
1	710-0643	1	HHCS: 5/16"-18X 1.0"; GR5: LOCK
2	710-1309	1	SCREW: MACH: 5/16"-18 x .75
3	736-0187	1	WASHER: FLAT: .64 X 1.24 X .06: HT
4	736-0242	1	WASHER: BELL: .340X .872 X .060
5	738-0919	1	SHAFT: STEERING: 5/8" SPLINE X 21.86" LG
6	741-0656A	1	BEARING: FLANGE: HEX: 5/8" PM
7	748-0389	1	CAP: 1.25 X .16
8	769-01171A	1	THIS INSTRUCTION SHEET

Pre-Service Preparation:

NOTE: All references to left, right, front and rear of the unit are determined by standing in the operator's position and facing the direction of forward travel.

1. Remove the key from the ignition switch.
2. Disconnect spark plug wire(s) from the spark plug(s) and ground to engine block.
3. Fully depress the clutch/brake pedal and set the speed control lever all the way to the rear and release it into the parking brake position.
4. Allow engine and muffler to cool before proceeding.
5. For ease of repair remove the mowing deck. Refer to the DECK REMOVAL SECTION of the Owner's Manual.

NOTE: Photos used in this instruction are of a Bolens model and are representative of applicable 660-690 series units.

Steering Shaft Removal:

6. Using a flat blade screwdriver, pry the steering wheel cap from the center of the steering wheel. See Figure 2.

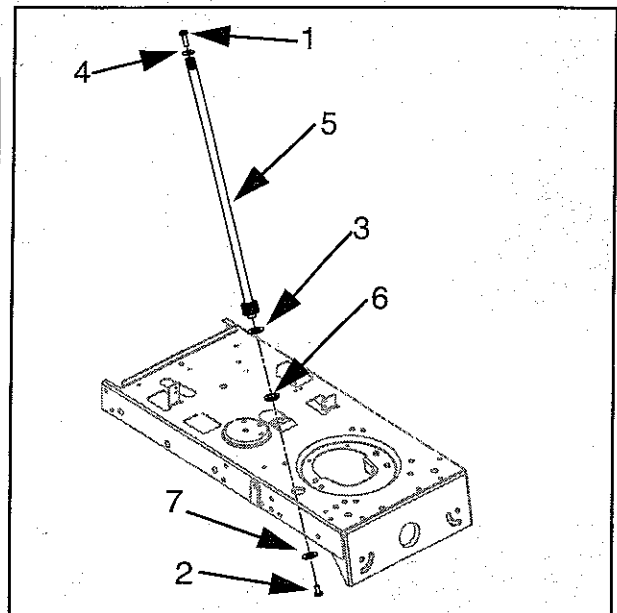

FIGURE 1

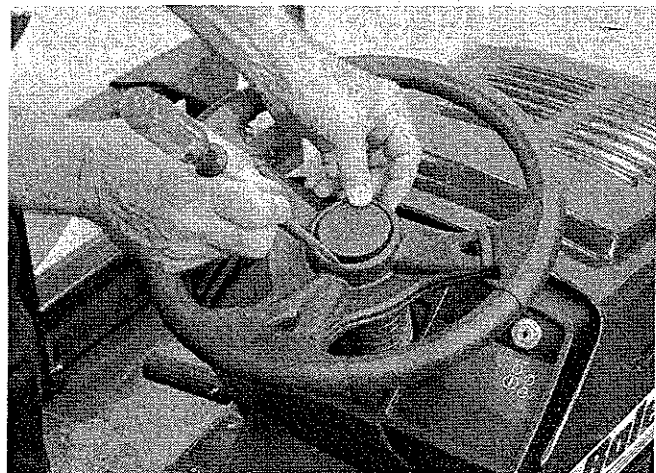

FIGURE 2

7. Using a 1/2" socket and extension remove and discard the hex cap screw and bell washer securing the steering wheel to the steering shaft.

8. Raise the rider to gain access to the underside of the unit. Securely position the unit on jack stands or blocks and ensure the unit cannot roll.

9. Using an impact gun with a large Phillips Head socket, remove the machine screw and cap securing the steering shaft to the frame. Discard the machine screw and cap. See Figure 3.

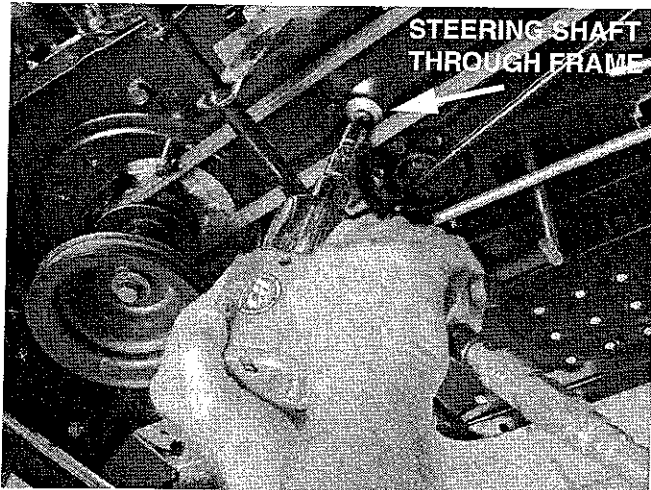

FIGURE 3

10. Raise the hood and disconnect the head light wiring connector located inside the lower right side of the front grille. See Figure 4.

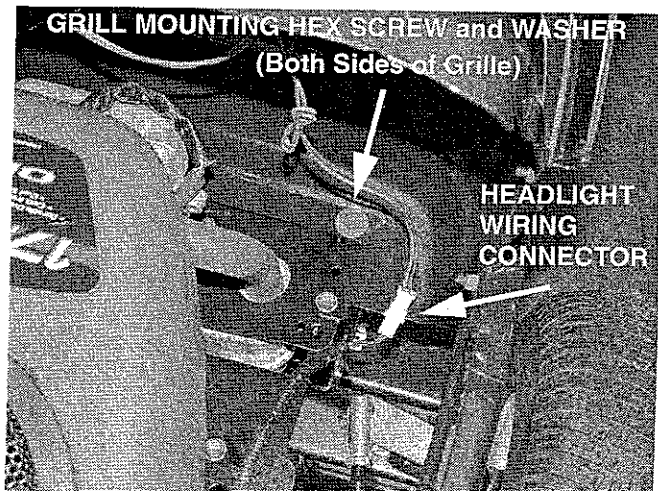

FIGURE 4

11. Using a 1/2" socket and extension, remove the two (2) hex screws and flat washers securing the grille to the frame. See Figure 4.

12. UNITS WITH ENGINE SIDE PANELS - Using a 3/8" socket, remove the four (4) (two on each side of the unit) self-tapping screws securing the rear of each side panel to the dash panel and frame. See Figure 5.

UNITS WITHOUT ENGINE SIDE PANELS - Using a 3/8" socket and 7/16" wrench, remove the two (2) (one on each side of the unit) hex screws and hex nuts securing the tubular grille braces to the dash panel.

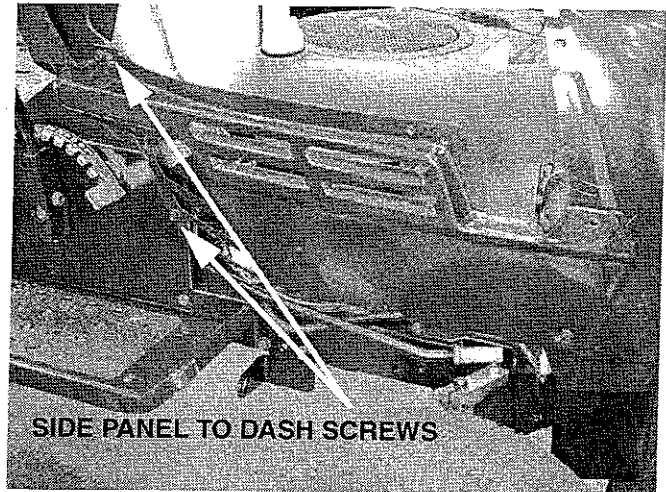

FIGURE 5

13. Remove the entire hood/grille/side panel (or hood/grille/brace) assembly from the unit.

14. Remove the harness connector and single blade connector from the back of the ignition switch. See Figure 6.



FIGURE 6

15. Using a 3/8" socket, remove the six (6) screws securing the dash panel to the frame. See Figure 7.

DASH MOUNTING
SCREWS (2)

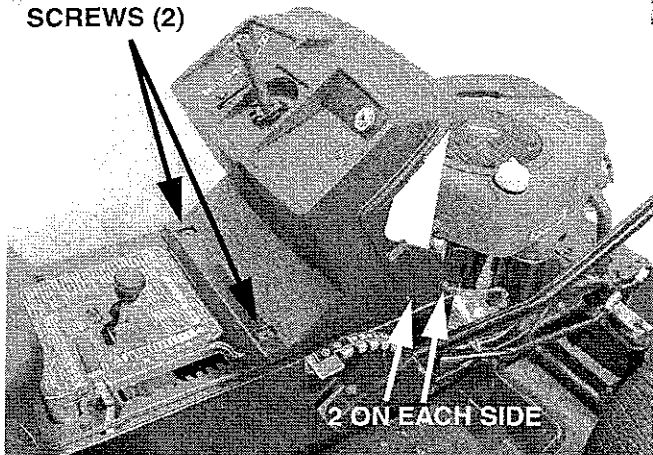

FIGURE 7

16. Lift and pivot the dash panel to the left while removing the steering shaft from the bushing in the frame. See Figure 8.

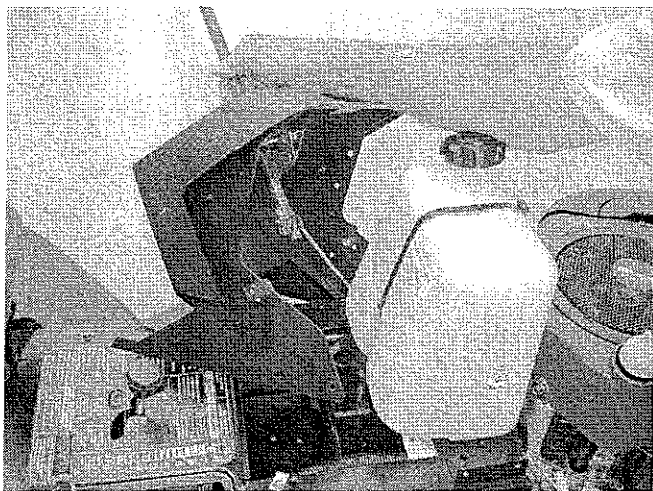

FIGURE 8

17. Slide the steering shaft from the hole in the dash panel. Discard the steering shaft.

18. Remove and discard the black plastic hex flange bearing.

NOTE: Wipe clean and inspect the steering segment gear for uncharacteristic wear or damage. Normally, the steering segment gear has not worn when the steering shaft gear has shown uncharacteristic wear. If the steering segment gear (not part of this service kit) is worn or damaged order the steering segment gear and replace.

Refer to the 2004 MTD Technical Handbook (Form No. 769-00960/Paper or 769-00941 CD/CD) Pages 4 and 5 for Steering Segment Gear Removal.

New Steering Shaft Installation:

18. When installing the new lower Hex Flange Bearing, Item 6, ensure that it is seated firmly and squarely into the hex hole in the frame.

19. Pre-installation lubrication - Being careful not to get any lubrication into the lower threaded end of the Steering Shaft, Item 5, lubricate the worm gear on the shaft and the short end next to the worm gear.

20. Lubricate both sides of the Flat Washer, Item 3, and place onto the short end of the steering shaft against the worm gear.

21. Install the steering shaft in the reverse order of removal.

NOTE: When mating the worm gear of the steering shaft to the steering segment gear the front wheels must be positioned straight forward. This should place the worm gear in the middle of the segment gear ensuring equal left and right hand turn capability.

NOTE: The recess in the Cap, Item 7, goes towards the steering shaft.

NOTE: When installing the Pan Head Machine Screw, Item 2, torque to 17 to 20 Ft-Lbs.

NOTE: If steering adjustment is necessary refer to the 2004 MTD Technical Handbook (Form No. 769-00960/Paper or 769-00941 CD/CD) Bolens Service Manual - Bolens 683 Series Box Frame Tractor - Section 10, STEERING ADJUSTMENT.