

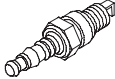

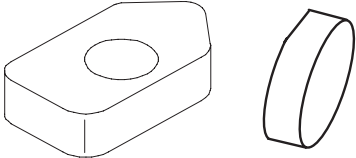







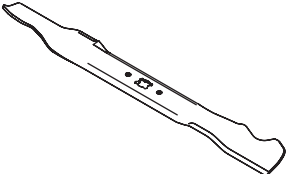
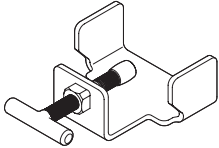
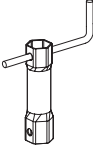
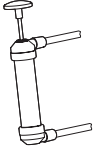
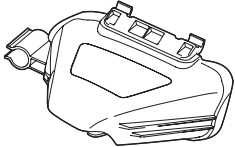
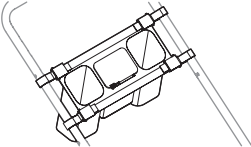
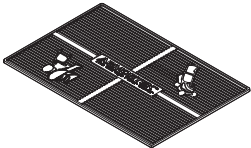
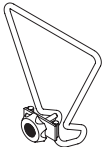
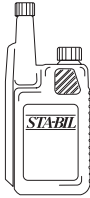

Component	Part Number and Description
	BS-796112S Spark Plug (Briggs & Stratton) 951-10292 Spark Plug (MTD)
	490-200-0011 Air Filter Cartridge (Briggs & Stratton) 951-10732 Air Cleaner Kit (MTD)
	BS-795472 Fuel Tank Cap (Briggs & Stratton) 951-12738 Fuel Cap Assembly (MTD)
	951-10358A Fuel Filter (MTD)
	734-04063A Wheel
	731-0064 Discharge Chute
	942-0640 Mulching Blade

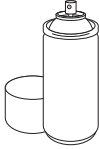
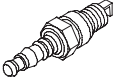
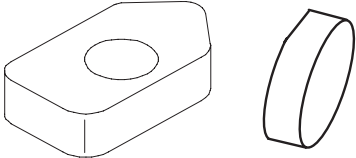
Component	Model Number and Description
	<p>490-850-0005 Blade Removal Tool — Holds blade in place for faster, safer removal.</p>
	<p>SPW-134 Spark Plug Wrench — Dual ended wrench to serve multiple uses. Fits <math>\frac{3}{4}</math>" or <math>\frac{13}{16}</math>" hex plug.</p>
	<p>490-850-0008 Oil Siphon — Makes it easy to transfer gas, oil and liquids from tank to container.</p>
	<p>490-850-0016 Side Discharge Blower — Blows leaves, grass clippings and debris. Eliminates need for separate blower. Easy installation with no tools.</p>
	<p>490-850-0015 Cargo Carrier — Conveniently holds drinks, tools and more. Simple installation. Attaches in less than two minutes with no tools.</p>
	<p>490-241-0034 Garage Floor Mat — Anti-skid mat, measures 24" x 36". Projects garage floor from stains.</p>
	<p>490-850-0012 Mower Kick Stand — Keeps mower stable for changing/ sharpening blade and cleaning underside of deck.</p>

Component	Model Number and Description
	<p>22216 STA-BIL® fuel Stabilizer, 32 oz — Treats 80 gallons of fuel. Keeps stored fuel fresh for quick, easy starts. Prevents corrosion from moisture and ethanol-induced attraction. Prevents gum and varnish.</p>
	<p>490-290-0012 Mower Cover — Protects your mower against sun, rain and dust damage. Coated for maximum water resistance and repellency. U.V. and mildew resistant</p>
	<p>490-900-0062 Non-Stick Mower Deck Spray — Long-Lasting anti-stick graphite spray. Prevents grass clippings buildup in mowing deck.</p>

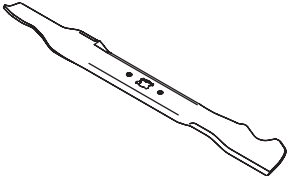
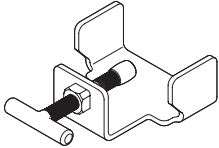
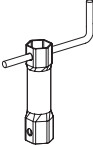
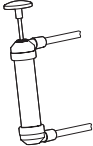
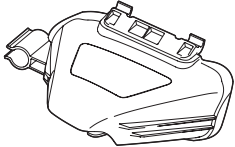
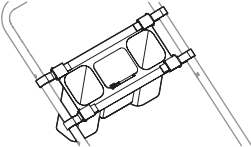
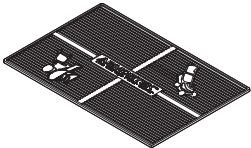
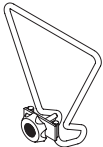
Component	Part Number and Description
	BS-796112S Spark Plug (Briggs & Stratton) 951-10292 Spark Plug (MTD)
	490-200-0011 Air Filter Cartridge (Briggs & Stratton) 951-10732 Air Cleaner Kit (MTD)
	BS-795472 Fuel Tank Cap (Briggs & Stratton) 951-12738 Fuel Cap Assembly (MTD)
	951-10358A Fuel Filter (MTD)
	734-04063A Wheel
	731-0064 Discharge Chute
	942-0640 Mulching Blade

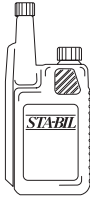
Component	Model Number and Description
	<p>490-850-0005 Blade Removal Tool — Holds blade in place for faster, safer removal.</p>
	<p>SPW-134 Spark Plug Wrench — Dual ended wrench to serve multiple uses. Fits 3/4" or 13/16" hex plug.</p>
	<p>490-850-0008 Oil Siphon — Makes it easy to transfer gas, oil and liquids from tank to container.</p>
	<p>490-850-0016 Side Discharge Blower — Blows leaves, grass clippings and debris. Eliminates need for separate blower. Easy installation with no tools.</p>
	<p>490-850-0015 Cargo Carrier — Conveniently holds drinks, tools and more. Simple installation. Attaches in less than two minutes with no tools.</p>
	<p>490-241-0034 Garage Floor Mat — Anti-skid mat, measures 24" x 36". Projects garage floor from stains.</p>
	<p>490-850-0012 Mower Kick Stand — Keeps mower stable for changing/ sharpening blade and cleaning underside of deck.</p>

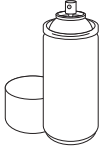
Component	Model Number and Description
	<p>22216 STA-BIL® fuel Stabilizer, 32 oz — Treats 80 gallons of fuel. Keeps stored fuel fresh for quick, easy starts. Prevents corrosion from moisture and ethanol-induced attraction. Prevents gum and varnish.</p>
	<p>490-290-0012 Mower Cover — Protects your mower against sun, rain and dust damage. Coated for maximum water resistance and repellency. U.V. and mildew resistant</p>
	<p>490-900-0062 Non-Stick Mower Deck Spray — Long-Lasting anti-stick graphite spray. Prevents grass clippings buildup in mowing deck.</p>

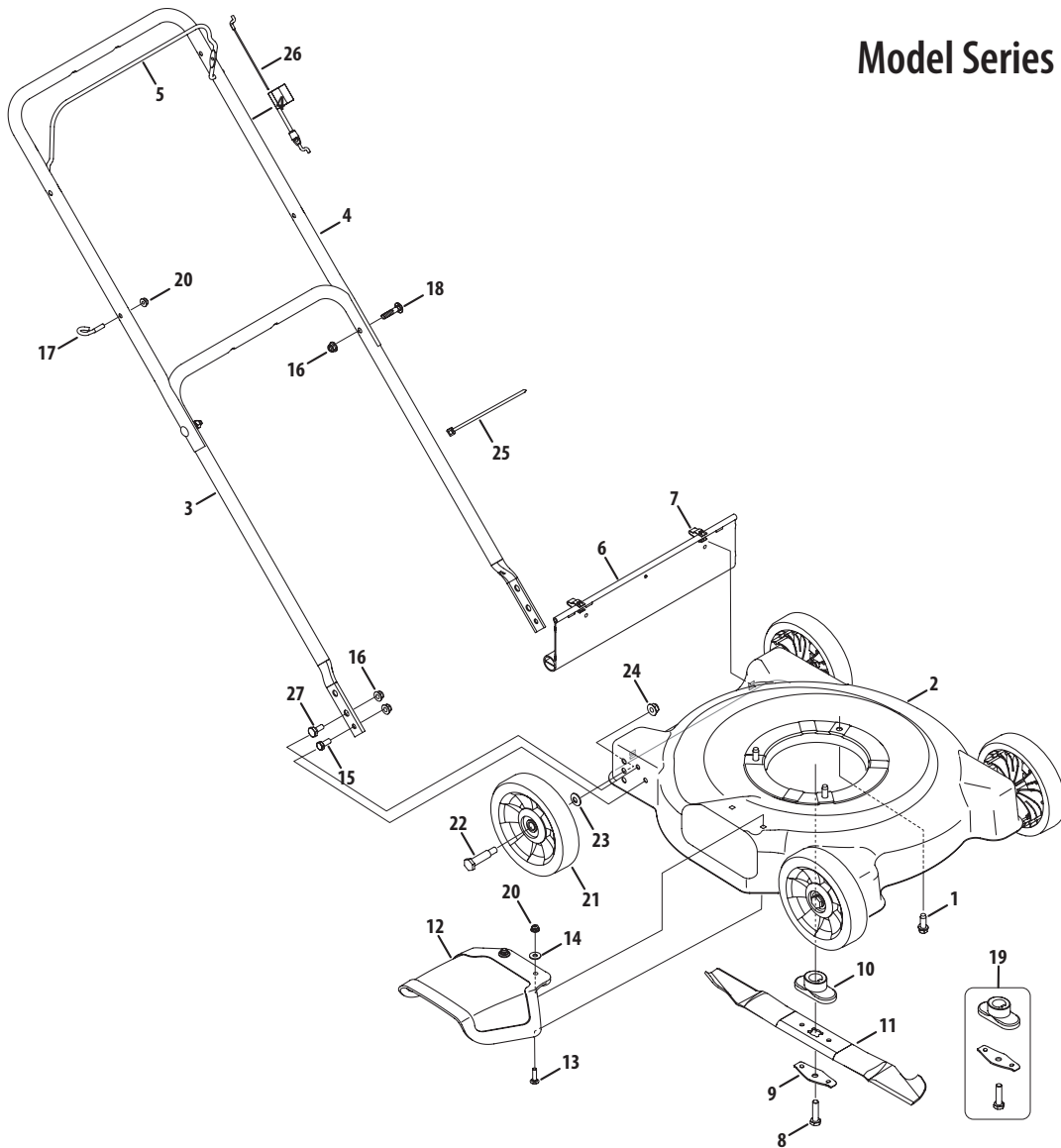

Ref.	Part Number	Description
1	710-0654A	Hex Ind. Washer Screw, 3/8-16 x 1.0
2	787-01759-0638	Cutting Deck, 20" - Red
	787-01759-0709	Cutting Deck, 20" - Green
3	749-04037	Lower Handle
4	749-1092A	Upper Handle
5	747-1161A	Blade Control
6	731-06953	Rear Flap
7	732-04631A	Hinge Clip
8	710-1044	Screw, 3/8-24 x 1.5"
9	736-0524B	Blade Bell Support
10	748-0376E	Blade Adapter
11	942-0640	Cutting Blade
12	731-0064	Discharge Chute
13	710-0932A	Carriage Screw, 1/4-20 x 1.0"
14	736-0173	Flat Washer

Ref.	Part Number	Description
15	710-3008	Hex Screw, 5/16-18 x .75"
16	712-04063	Flange Lock Nut, 5/16-18
17	710-1205	Eye Bolt
18	710-0262	Carriage Bolt, 5/16-18 x 1.5"
19	753-06315	Blade Adapter Kit (Incl. Ref. 8-10)
20	712-04064	Flange Lock Nut, 1/4-20
21	734-04063A	Wheel, 7" Star-Dia., Oys. Gray
22	938-0533	Shoulder Screw, .498 x 1.635
23	736-0105	Bell Washer
24	712-04065	Flange Lock Nut, 3/8-16
25	725-0157	Cable Tie
26	946-0957	Control Cable, 148cc
	946-04703	Control Cable, 139cc
27	938-04033	Shoulder Screw, 5/16-18 x.428"