









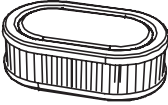
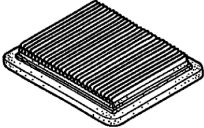
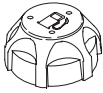

Component	Part Number and Description
	759-3336 Spark Plug (Briggs & Stratton) 98079-55846 Spark Plug (NGK BPR5ES) (Honda)
 	BS-298090S† Fuel Filter (Briggs & Stratton) 16952-ZA8-800† Fuel Filter (Honda)
 	BS-798452 Air Filter Cartridge (Briggs & Stratton) 17211-ZL8-023 Air Cleaner Element (Honda)
 	BS-799585 Fuel Cap (Briggs & Stratton) 17620-Z0J-800 Fuel Cap (Honda)
	634-04607 Wheel (Front)
 	634-04660 Wheel (Rear - Low Wheel) 634-04626 Wheel (Rear - High Wheel)
	731-07131 Discharge Chute
 	942-0741A Mulching Blade 942-0741-X Xtreme Mulching Blade
	964-04117A Grass Bag

† If Equipped

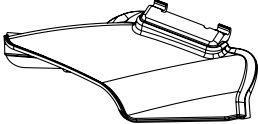
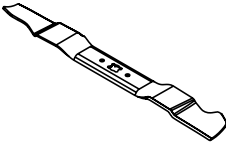
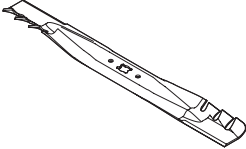
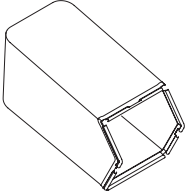
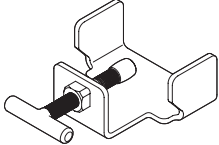
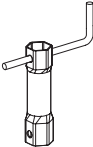
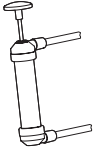
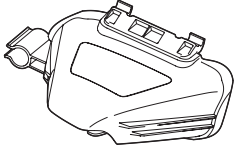
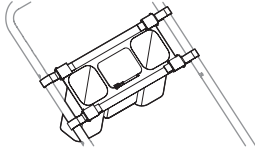
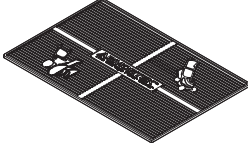
Phone (800) 828-5500 or (330) 558-7220 to order replacement parts or a complete Parts Manual (have your full model number and serial number ready). Parts Manual downloads are also available free of charge at www.troybilt.com

Component	Model Number and Description
	490-850-0005 Blade Removal Tool — Holds blade in place for faster, safer removal.
	SPW-134 Spark Plug Wrench — Duel ended wrench to serve multiple uses. Fits 3/4" or 13/16" hex plug.
	490-850-0008 Oil Siphon — Makes it easy to transfer gas, oil and liquids from tank to container.
	490-850-0016 Side Discharge Blower — Blows leaves, grass clippings and debris. Eliminates need for separate blower. Easy installation with no tools.
	490-850-0015 Cargo Carrier — Conveniently holds drinks, tools and more. Simple installation. Attaches in less than two minutes with no tools.
	490-241-0034 Garage Floor Mat — Anti-skid mat, measures 24" x 36". Projects garage floor from stains.
	490-850-0012 Mower Kick Stand — Keeps mower stable for changing/ sharpening blade and cleaning underside of deck.

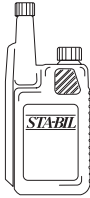
Phone (800) 800-7310 or (330) 220-4683 to order attachments and accessories. Have your mower's full model number and serial number ready to assure compatibility. Items can also be purchased online at www.troybilt.com

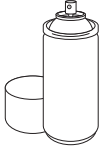
Component	Model Number and Description
	<p>22216 STA-BIL® fuel Stabilizer, 32 oz — Treats 80 gallons of fuel. Keeps stored fuel fresh for quick, easy starts. Prevents corrosion from moisture and ethanol-induced attraction. Prevents gum and varnish.</p>
	<p>490-290-0012 Mower Cover — Protects your mower against sun, rain and dust damage. Coated for maximum water resistance and repellency. U.V. and mildew resistant</p>
	<p>490-900-0062 Non-Stick Mower Deck Spray — Long-Lasting anti-stick graphite spray. Prevents grass clippings buildup in mowing deck.</p>

Painted Parts

When ordering painted service parts, a four digit color suffix must be added to the part number (e.g. 783-XXXXX-0637). Please refer to the table below for current color codes:

0637	Black
0709	Dark Green (Bolens, Yard-Man)
0662	Oyster Gray (MTD Gold)
0638	Red (Yard Machines, Huskee, Troy-Bilt, MTD)
0691	Black Jack (MTD Gold, MasterCut)

0674	Yellow (Yard-Man)
0650	Metallic Red (White Outdoor)
0629	Silver Flake (MTD Platinum)
04038	Day Orange (Daedong)
04033	Flint Mica (Troy-Bilt XP)

Model TB110 (11A-A230)

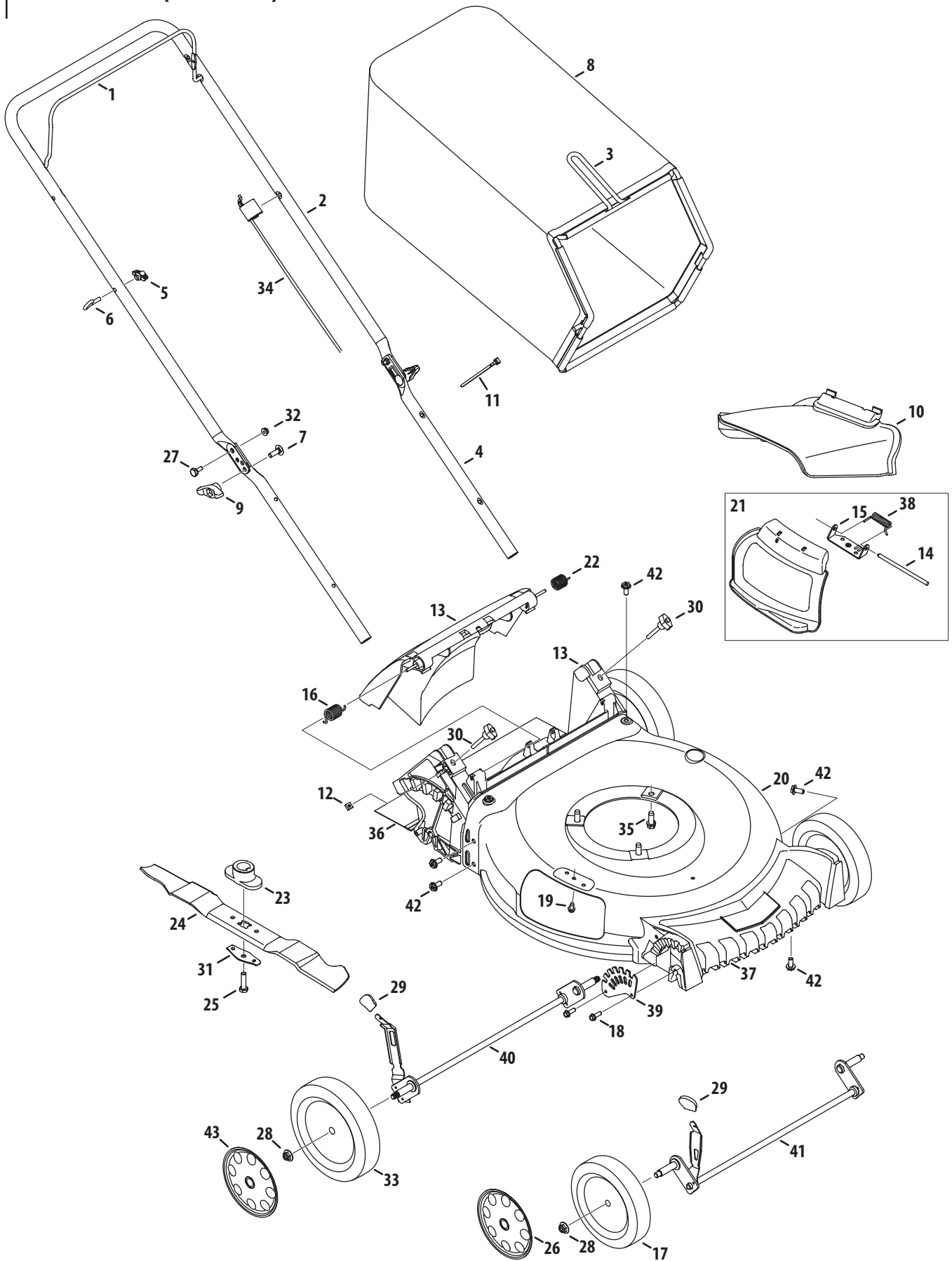

Model TB110 (11A-A230)

Ref No.	Part Number	Description
1	747-05214A	Blade Control
2	749-04681	Upper Handle
3	747-05226	Grass Catcher Frame
4	749-04608A	Lower Handle
5	720-0279	Wing Nut
6	710-1205	Rope Guide
7	710-04998	Carriage Screw ,5/16-18
8	964-04117A	Grass Bag
9	720-04124	Wing Knob
10	731-07131	Side Chute
11	725-0157	Cable Tie
12	712-04222	Nut, Sq., 1/4-20
13	631-04369A	Rear Discharge Door Assembly
	631-04371A	Rear Discharge Door Assembly- (Lowe's)
14	747-0710A	Hinge Pin
15	787-01779	Chute Deflector Bracket
16	732-04673	Torsion Spring - RH
17	634-04607	Front Wheel
18	710-0895	Screw, 1/4-15 x .750
19	710-05073	Screw, 1/4-20 x .500
20	787-01869A	Deck , 21"
21	987-02516	Hinged Mulch Plug Assembly

Ref No.	Part Number	Description
22	732-04674	Torsion Spring - LH
23	748-0376E	Blade Adapter
24	942-0741A	Mulching Blade
25	710-1044	Screw , 3/8-24 x 1.50
26	731-07197	Hub Cap, 7"
27	738-04419A	Sldr. Screw, .375 x .126 x 1/4-20
28	712-04217	Flange Lock Nut, 3/8-16
29	720-04131A	Adjustment Lever Knob
30	720-04127B	Wing Nut
31	736-0524B	Blade Bell Support
32	712-04064	Nut, Flange Lock, 1/4-20
33	634-04660	Rear Wheel
34	946-0957	Control Cable
35	710-04683A	TT Sems Screw, 3/8-16 x 1.0
36	731-07203	Trail Shield
37	731-07195A	Front Cover
38	732-1014C	Torsion Spring
39	787-01818A	Front Height Adjuster Plate
40	911-04142	Rear Axle Assembly
41	911-04143B	Front Axle Assembly
42	710-04995A	Screw, 5/16-14 x .750
43	731-07198	Hub Cap, 8"

Model TB130 (11A-B21/9Q)

Ref No.	Part Number	Description
1	747-05214A	Blade Control
2	749-04681	Upper Handle
3	747-05226	Grass Catcher Frame
4	749-04608A	Lower Handle
5	720-0279	Wing Nut
6	710-1205	Rope Guide
7	710-04998	Carriage Screw ,5/16-18
8	964-04117A	Grass Bag
9	720-04124	Wing Knob
10	731-07131	Side Chute
11	725-0157	Cable Tie
12	712-04222	Nut, Sq., 1/4-20
13	631-04371A	Rear Discharge Door Assembly
	631-04369A	Door Assembly, International
14	747-0710A	Hinge Pin
15	787-01779	Chute Deflector Bracket
16	732-04673	Torsion Spring - RH
17	634-04607	Front Wheel
18	710-0895	Screw, 1/4-15 x .750
19	710-05073	Screw, 1/4-20 x .500
20	787-01869A	Deck , 21"
21	987-02516	Hinged Mulch Plug Assembly

Ref No.	Part Number	Description
22	732-04674	Torsion Spring - LH
23	748-04096	Blade Adapter
24	942-0741A	Mulching Blade
25	710-1044	Screw , 3/8-24 x 1.50
26	731-07197	Hub Cap - Front
	731-07199	Hub Cap - Rear
27	738-04419A	Sldr. Screw, .375 x .126 x 1/4-20
28	712-04217	Flange Lock Nut, 3/8-16
29	720-04131A	Adjustment Lever Knob
30	720-04127B	Wing Nut
31	736-0524B	Blade Bell Support
32	712-04064	Nut, Flange Lock, 1/4-20
33	634-04626	Rear Wheel
34	946-04670A	Control Cable
35	710-04683A	TT Sems Screw, 3/8-16 x 1.0
36	731-07203	Trail shield
37	731-07195A	Front Cover
38	732-1014C	Torsion Spring
39	787-01818A	Front Height Adjuster Plate
40	911-04144A	Rear Axle Assembly
41	911-04143B	Front Axle Assembly
42	710-04995A	Screw, 5/16-14 x .750