

Model 57M1

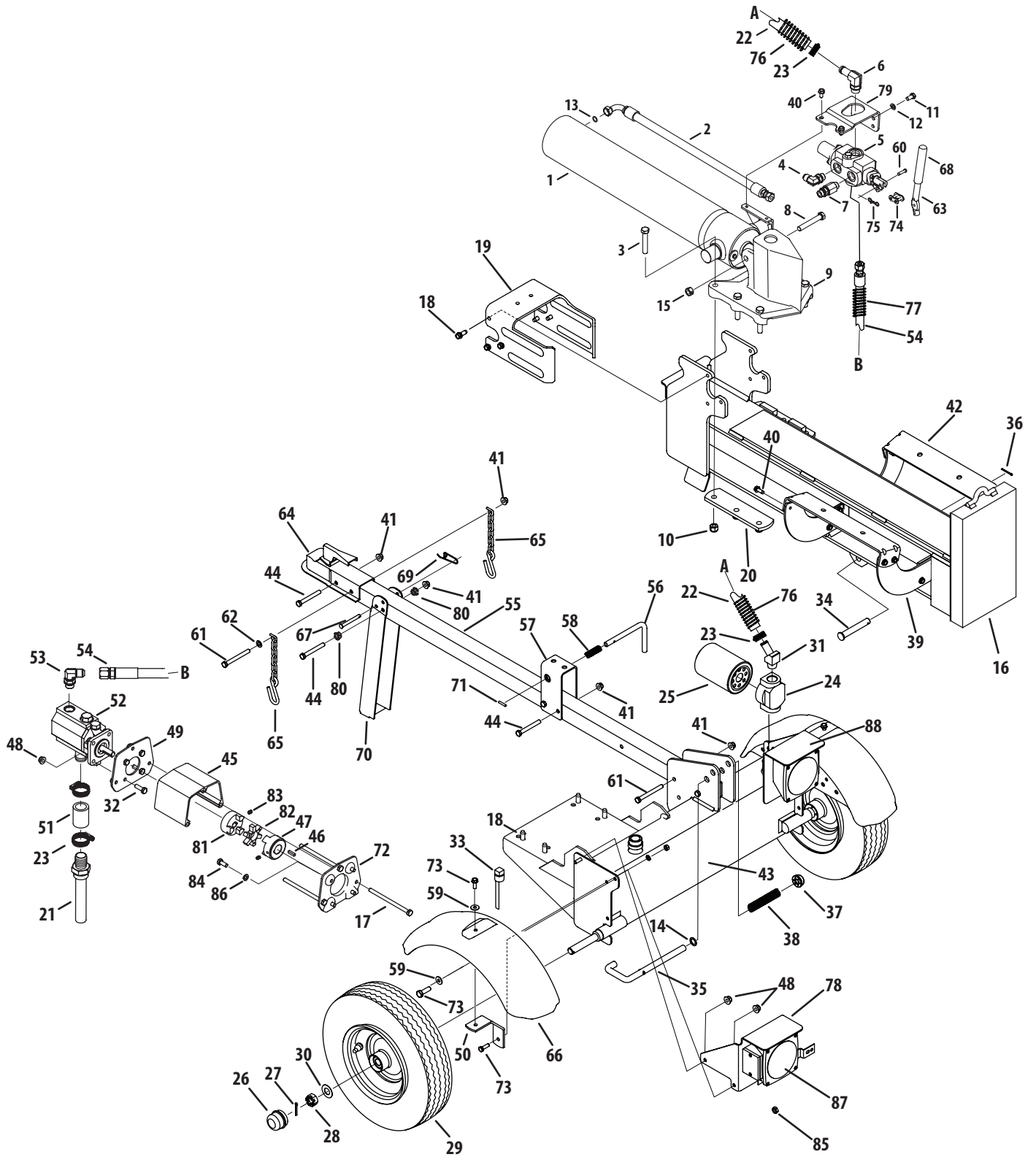

Ref.	Part Number	Description
1	918-04713	Hydraulic Cylinder
2	727-04362	Hydraulic Tube
3	710-1018	Hex Cap Screw, 1/2-20 x 2.75
4	737-04320	90 Degree Solid Adapter
5	718-04706P	Control Valve
6	737-04307	Return Elbow
7	737-04309	Nipple Pipe, 1/2-14
8	710-1806	Hex Cap Screw, 1/2-13 x 3.25
9	719-04529	Wedge Assembly
10	912-3058	Hex Lock Nut, 1/2-20
11	710-0216	Hex Cap Screw, 3/8-16 x .75
12	936-0169	Lock Washer, 3/8
13	721-04411	O-Ring, .489 ID x .070 Dia.
14	936-0116	Flat Washer, .635 x.93 x.06
15	712-3022	Hex Lock Nut, 1/2-13
16	681-04112	Beam Assembly
17	710-0190	Hex Screw, 5/16-18 x 4.00
18	710-04683A	Self Tapping Screw, 3/8-16 x 1.0
19	781-04426	Dislodger Bracket
20	781-0790A	Back Plate
21	737-04308	Inlet Filter
22	727-0443	Return Hose, 3/4 x 44
23	726-0132	Hose Clamp, 5/8
24	737-04267	Filter Housing
25	723-0405	Oil Filter
26	734-0873	Hub Cap
27	714-0162	Cotter Pin
28	712-0359	Slotted Nut, 3/4-16
29	634-0186	Complete Wheel Assembly
	921-0168	Dust Seal
	941-04089	Roller Bearing
30	936-0351	Flat Washer, .760 x.500
31	737-04323	Hydraulic Fitting, 1 1/16 Orb x .75
32	710-0376	Hex Screw, 5/16-18 x 1.00
33	737-0348A	Vented Dipstick
34	711-05169	Clevis Pin
35	747-04983	Lock Rod
36	914-0470	Cotter Pin

Ref.	Part Number	Description
37	726-0214	Push Cap
38	732-0583	Compression Spring
39	781-04293	Log Tray Bracket
40	710-04484	Hex Washer Screw, 5/16-18 x .750
41	712-04065	Flange Lock Nut, 3/8-16
42	781-04179	Log Tray
43	681-04113	Frame Assembly
44	710-0521	Hex Bolt, 3/8-16 x 3
45	719-0278	Coupling Shield
46	914-0122	Square Key, 3/16" x .75
47	718-04474	Coupling, .750
48	712-04063	Flange Lock Nut, 5/16-18
49	781-0097	Rear Coupling Support Bracket
50	781-1024A	Fender Mounting Bracket
51	727-04356	Hose
52	918-04127	Gear Pump
53	737-04320	45 Degree Elbow Fitting
54	727-04288	High Pressure Hydraulic Hose
55	781-04424	Tongue Assembly
56	747-1261	Latch Rod
57	781-1045	Latch
58	932-3127	Compression Spring
59	736-0371	Flat Washer
60	711-04585	Clevis Pin
61	710-3085	Hex Cap Screw, 3/8-16 x 3.50
62	936-0185	Flat Washer, .375 x.738 x.063
63	747-04539A	Hydraulic Valve Control
64	681-04030	Hitch Coupling Assembly
65	713-0433A	Chain
66	731-2496A	Fender
67	911-0813	Clevis Pin
68	720-04088	Grip
69	732-0194	Spring Pin
70	781-04430	Jack Stand
71	715-0120	Spiral Pin
72	781-0098A	Front Coupling Support Bracket
73	710-0602	Self-Tapping Screw, 5/16-18 x 1.00
74	913-04036	Valve Handle Link

Continued on next page

Model 57M1

Ref.	Part Number	Description
75	714-04040	Cotter Pin, Bow Tie
76	781-0526A	Hose Guard, 48"
77	781-0538A	Hose Guard, 44"
78	781-1027A	RH Light Bracket
79	781-04418	Outer Valve Bracket
80	941-0475	Plastic Bushing, .380 ID
81	718-04392	Coupling, .500
82	735-04103	Spider Bushing
83	710-1842A	Set Screws
84	710-0157	Hex Cap Screw, 5/16-24 x .75
85	912-3008	Jam Nut, 3/8-16
86	936-0119	Lock Washer, 5/16
87	625-0062	Light Assembly Kit
88	681-0164	LH Light Bracket