

SECTION 11: PARTS LIST FOR MODEL V17

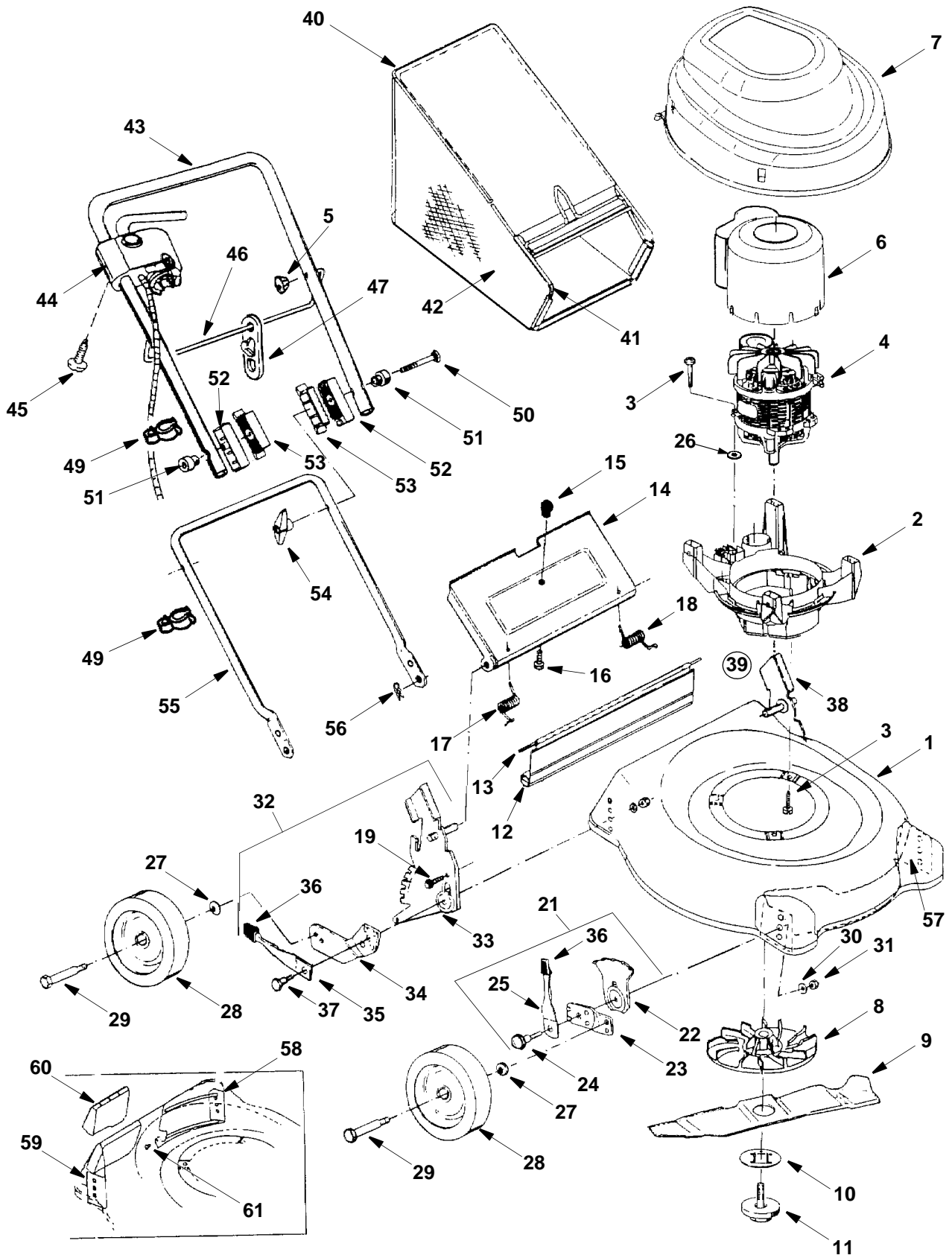

Model V17

Ref. No.	Part No.	Part Description	Ref. No.	Part No.	Part Description
1	782-0054B-0638	19" Deck	32	682-0516-0637	Handle Bracket Assy, RH (Includes #33-37)
2	731-2425	Motor Base	33	682-0514	Handle Bracket, RH
3	710-1756	Screw, M7 x 25	34	14765	Pivot Bar, RH
4	724-0309	Electric Motor, 115V, 1500W		14766	Pivot Bar, LH
5	712-0397	Wing Nut	35	732-0417A	Spring Lever
6	731-2400	Air Guide Cover	36	720-0426	Height Adjustment Knob
7	731-2383-0637	Hood	37	738-0507B	Shoulder Bolt
8	631-0132	Blade Hub Assembly	38	682-0513	Handle Bracket, LH
9	742-0826	Cutting Blade (Mulch/Bag)	39	682-0515-0637	Handle Bracket Assy, LH (Includes #34-38)
10	782-7051	Blade Locking Plate	40	764-04003	Rear Catcher Frame
11	624-0078	Blade Screw	41	764-04004	Front Catcher Frame
12	731-1261	Trailing Shield	42	664-04014	Grass Bag
13	732-0712	Wire Rod	43	749-0886	Upper Handle
14	782-7025-0637	Rear Discharge Door	44	725-04074	Cord and Switch Assembly
15	720-0275	Knob	45	710-1757	Screw
16	710-0192	Truss Screw, 10-24 x .38"	46	747-0790	Cord Control Rod
17	732-0678	Door Spring, RH	47	726-0368	Cord Restraint
18	732-0677	Door Spring, LH	49	731-2422	Cable Guide
19	710-0896	Washer Hd Screw, 1/4-14 x .625	50	710-0450	Carriage Bolt
21	14578	Height Adj. Assy. RH (shown)	51	731-1388	Insulating Knob Spacer
	14579	Height Adj. Assy. LH (not shown) (Both Include Ref #22-25,36)	52	731-1268	Upper Handle Insulator
22	15261A	Adjusting Plate	53	731-1267	Lower Handle Insulator
23	15262B	Pivot Bar	54	720-0241	Handle Knob
24	738-0507B	Shoulder Bolt	55	749-0885	Lower Handle
25	14832	Lever and Knob Assy. (Incl #36)	56	714-0104	Internal Cotter Pin
26	736-0695	Washer	57	782-5025-0637	Front Baffle
27	736-0105	Bell Washer	58	782-5026-0637	Rear Baffle
28	734-1987	Wheel	59	782-5004-0637	Rear Mulch Baffle
29	738-0102	Axle Bolt	60	731-2386	Rear Mulch Plug
30	736-0356	Bell Washer	61	710-1017	Tap Screw, 1/4-14 x .625"
31	712-0798	Nut			