

ANVIL- Crankshaft installation	24299
BIT- #2 pozdrive	24304
COLLAR- Bearing installation	24295
DRIVER- Check valve (carburetor)	24972
JACKSCREW- Crankshaft installation	A-24309
PLUG- Bearing & seal installation	24298
PLUG- Bearing installation	23756
PULLER- Magneto rotor	A-24290
Includes	
SCREW- Rotor remover (4)	24301
RING- Retaining (4)	67912
SLEEVE- Bearing & shaft installation	23196-1
SLEEVE- Crankshaft bearing installation	24300
SLEEVE- Seal protecting (crankcase)	24297
SLEEVE- Seal protecting (drivecase)	24291
WRENCH- Spanner (3 shoe clutch)	A-24060
Includes	
PIN- Dowel (3)	64309-1
BIT- Driver (torx) 1/4" shank	24982-01
BIT- Driver (torx) 5/16" shank	24982-02
WRENCH- Combination	A-24284
WRENCH- Spanner ("S" Clutch)	A-83791
Includes	
PIN- Clutch spanner (2)	23717-A
REAMER- Compression valve seat cleaning	A-24138
GAUGE- Feeler ( .015) point set	22486
GAUGE- Feeler ( .0125) rotor-coil air gap	24306
WRENCH- Spanner	A-23696-A
BIT- Pozidriv #3	24320

## ACCESSORIES

CARRY CASE	94758
COMPOUND- Sealing (Duxseal) (starter rope)	24352
KIT- Head exchanger	A-67947
INCLUDES	
SCREW 10-32 x .375	80870
KIT- Loctite	23488-B
KIT- Repair (Sprocket nose bar)	A-69496
Includes	
BEARING- Guide bar (2B)	70737
RIVET- Guide bar (4)	94853
ROPE- Starter, 250' reel	88848
DEVICE- Anti-kickback (std equip)	A-70790-A
Includes	
SCREW- #1/4-20 x 5/8	82335
TUBING- Rubber (fuel line) 10'	70310-99
TUBING- Rubber (oil line) 10'	93112-99
GREASE- Multi use	17193
SPRAY CAN- Black	22772
SPRAY CAN- Red	23475
KIT- Chain brake	A-70416-B
Includes	
SPROCKET & DRUM- (7 tooth, 3/8 pitch)	A-12294-2
WRENCH- Sprocket	68651
COVER- Brake lever	70393-A
SCREW- Plastite (3)	82215
SPRING- Torsion	70093-B
SCREW- Shoulder	69551
SUPPORT- Vibration mount	70506-A
SLEEVE- Headed	70313
HAND GUARD & LEVER	A-69660-A
BAND- Brake	94614
LEVER- Brake band	A-94813
PIN- Roll (3/16 x 1/2)	67911
SCREW- Pan hd	82258
COVER- Drivecase (w/dowel pin holes)	94616-1
KIT- Hand guard (opt) prior to Lot # 0227	A-70910
Includes	
WASHER (2)	68651-2
WASHER- Belleville #10 (2)	70788
SLEEVE	70911
SCREW- Machine flat hd 12-24 x 1 1/2	70926
SCREW- Flat hd 12-24 x 1	80945
NUT- Hex #12-24	81225
SCREW- Flat 12-24 x 1 1/2	82223

Ref #	Part Number	Qty	Description
24299	24299		ANVIL- Crankshaft installation
24304	24304		BIT- #2 pozidrive
24295	24295		COLLAR- Bearing installation
24972	24972		DRIVER- Check valve (carburetor)
A-24309	A-24309		JACKSCREW- Crankshaft installation
24298	24298		PLUG- Bearing & seal installation
23756	23756		PLUG- Bearing installation
A-24290	A-24290		PULLER- Magneto rotor
24301	24301		SCREW- Rotor remover (4)
67912	67912		RING- Retaining (4)
23136-1	23136-1		SLEEVE- Bearing & shaft installation
24300	24300		SLEEVE- Crankshaft bearing installation
24297	24297		SLEEVE- Seal protecting (crankcase)
24291	24291		SLEEVE- Seal protecting (drivecase)
A-24060	A-24060		WRENCH- Spanner (3 shoe clutch)
643091	643091		PIN- Dowel (3)
2498201	2498201		BIT- Driver (torx) 1/4" shank
2498202	2498202		BIT- Driver (torx) 5/16" shank
A-24284	A-24284		WRENCH- Combination
A-93791	A-93791		WRENCH- Spanner ("S" Clutch)
23717A	23717A		PIN- Clutch spanner (2)
A-24138	A-24138		REAMER- Compression valve seat cleaning
22486	22486		GAUGE- Feeler (.015) point set
24306	24306		GAUGE- Feeler (.0125) rotor-coil air gap
A23696A	A23696A		WRENCH- Spanner
24320	24320		BIT- Pozidrive #3
94758	94758		CARRY CASE
24352	24352		COMPOUND- Sealing (Duxseal) (starter rope)
A-67947	A-67947		KIT- Head exchanger
80870	80870		SCREW 10-32 x .375
23488-B	23488-B		KIT- Loctite
A-69496	A-69496		KIT- Repair (Sprocket nose bar)
70737	70737		BEARING- Guide bar (28)
94853	94853		RIVET- Guide bar (4)
68848	68848		ROPE- Starter, 250' reel
A70790A	A70790A		DEVICE- Anti-kickback (std. equip.)
82335	82335		SCREW- #1/4-20 x 5/8
7031099	7031099		TUBING- Rubber (fuel line) 10'
9311299	9311299		TUBING- Rubber (oil line) 10'
17193	17193		GREASE- Multi use
22772	22772		SPRAY CAN- Black
23475	23475		SPRAY CAN- Red
A70416B	A70416B		KIT- Chain brake
A122942	A122942		SPROCKET & DRUM- (7 tooth, 3/8 pitch)
68651	68651		WRENCH- Sprocket
70393A	70393A		COVER- Brake lever
82215	82215		SCREW- Plastite (3)
70093B	70093B		SPRING- Torsion
69551	69551		SCREW- Shoulder
70506A	70506A		SUPPORT- Vibration mount
70313	70313		SLEEVE- Headed
A69660A	A69660A		HAND GUARD & LEVER
94614	94614		BAND- Brake
A-94613	A-94613		LEVER- Brake band
67911	67911		PIN- Roll (3/16 x 1/2)
82258	82258		SCREW- Pan hd.
946161	946161		COVER- Drivecase (w/dowel pin holes)
A-70910	A-70910		KIT- Hand guard (opt.) prior to Lot #0227

Ref #	Part Number	Qty	Description
588512	588512		WASHER (2)
70788	70788		WASHER- Belleville #10 (2)
70911	70911		SLEEVE
70926	70926		SCREW- Machine flat hd. 12-24 x 1 1/2
80945	80945		SCREW- Flat hd. 12-24 x 1
81225	81225		NUT- Hex #12-24
82223	82223		SCREW- Flat 12-24 x 1 1/2

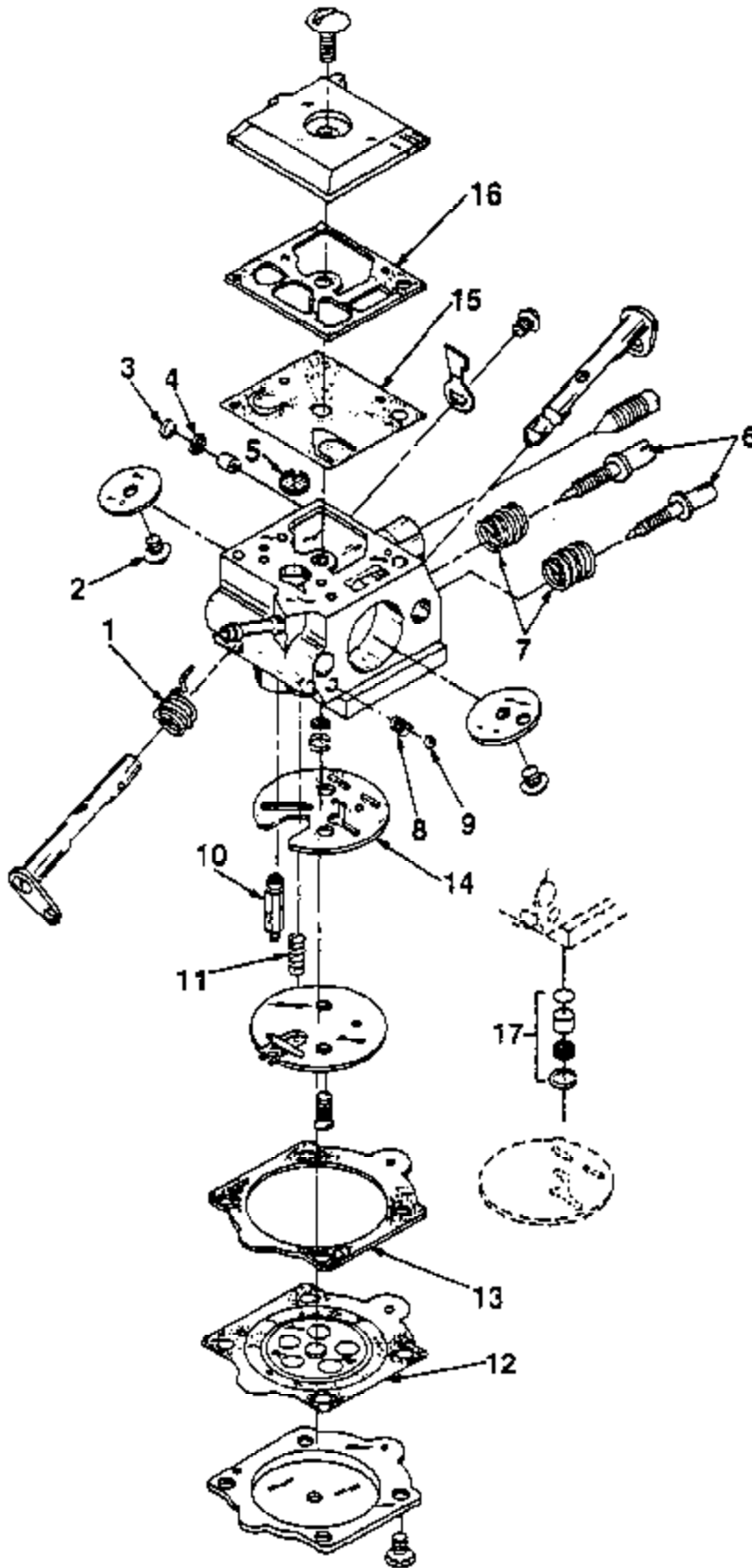

Ref #	Part Number	Qty	Description
1	93203A		Repair Kit Includes items 1 - 16.
2	93203A		Repair Kit Includes items 1 - 16.
3	93203A		Repair Kit Includes items 1 - 16.
4	93203A		Repair Kit Includes items 1 - 16.
5	93203A		Repair Kit Includes items 1 - 16.
6	93203A		Repair Kit Includes items 1 - 16.
7	93203A		Repair Kit Includes items 1 - 16.
8	93203A		Repair Kit Includes items 1 - 16.
9	93203A		Repair Kit Includes items 1 - 16.
10	93203A		Repair Kit Includes items 1 - 16.
11	93203A		Repair Kit Includes items 1 - 16.
12	93203A		Repair Kit Includes items 1 - 16.
12	94701		Gasket/Diaphragm Kit Includes items 12 - 16.
13	93203A		Repair Kit Includes items 1 - 16.
13	94701		Gasket/Diaphragm Kit Includes items 12 - 16.
14	93203A		Repair Kit Includes items 1 - 16.
14	94701		Gasket/Diaphragm Kit Includes items 12 - 16.
15	93203A		Repair Kit Includes items 1 - 16.
15	94701		Gasket/Diaphragm Kit Includes items 12 - 16.
16	93203A		Repair Kit Includes items 1 - 16.
16	94701		Gasket/Diaphragm Kit Includes items 12 - 16.
17	93910		Check Valve Repair

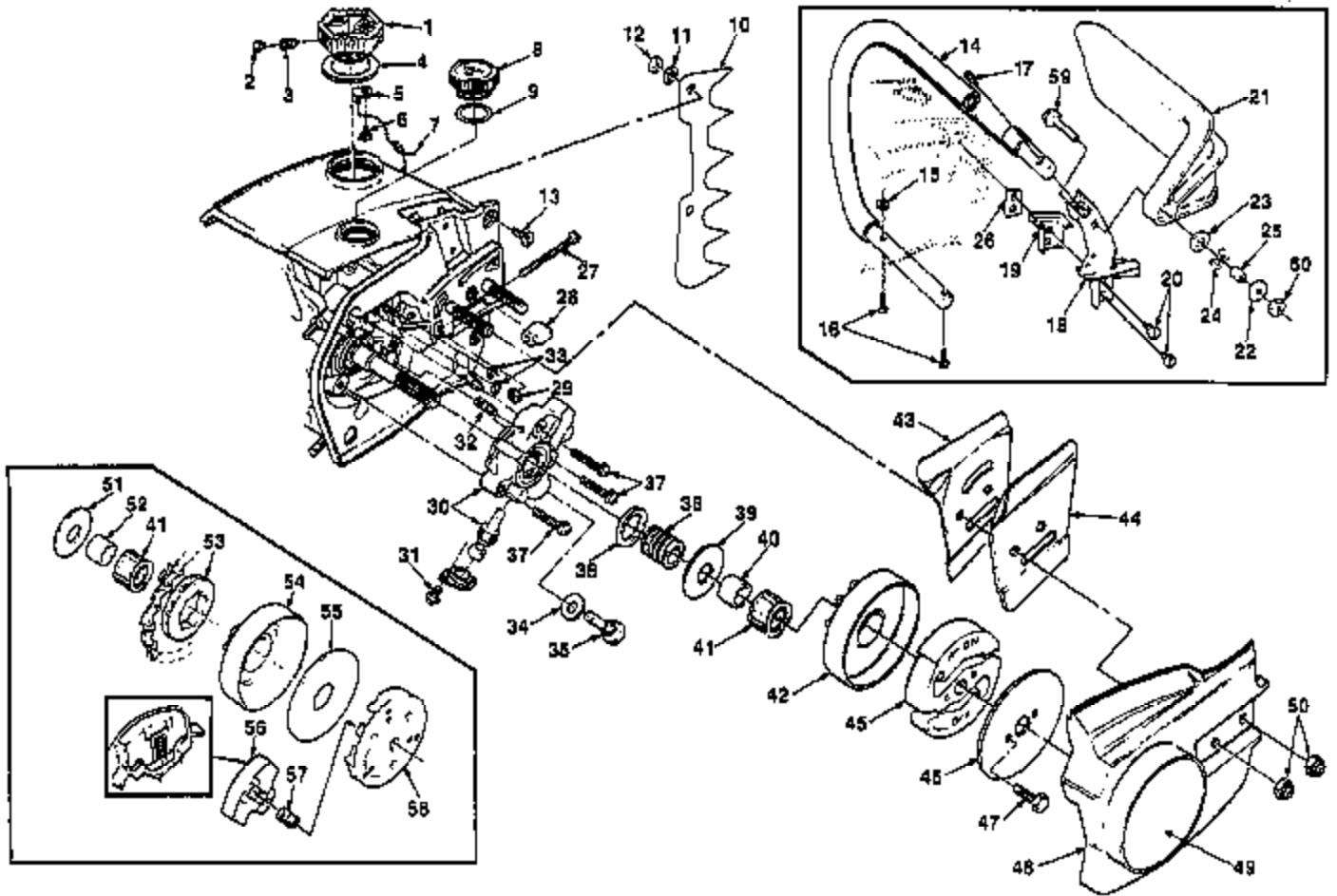

Ref #	Part Number	Qty	Description
1	A69500A	1	CAP- Fuel filler Includes items 2 - 7.
2	69454	1	FILTER- Filler cap
3	69451	1	VALVE- Check
4	69501	1	GASKET- Fuel filler cap
5	69502	1	CHAIN- Bead
6	82256	1	SCREW- Pan hd., plastite 6 x 1/4
7	69503	1	RETAINER- Filler cap
8	A65284B	1	CAP- Oil filler (Vented) Includes item 9.
	69451	1	VALVE- Check (Not shown)
9	69834	1	GASKET- Oil cap
10	A65181	1	KIT- Spiked bumper (accessory) Includes items 11 - 13.
11	830061	2	WASHER- Lock #10
12	810101	2	NUT- Hex 10-32
13	80035	2	SCREW- Flat 10-32 x 5/8
14	A69675	1	HANDLE BAR- Flush cut Includes items 15 - 16.
15	69890	1	WASHER
16	82268	2	SCREW- 10-32 x 7/8
17	82169	1	SCREW- Soc., 10-32 x 7/8
18	A70307B	1	KIT- Handle bar bracket (flush cut) Includes items 19 - 20.
19	65111	1	MOUNT- Shock
20	64613A	2	SCREW- Shoulder
21	95898	1	HAND GUARD
22	95935	1	WASHER
23	70788	1	WASHER- Belleville
24	95694	1	WASHER- Spring
25	95937	1	SPACER
26	65032	1	PLATE- Handle bar bracket
27	65175A	1	SCREW- Guide bar adjusting
28	651121	1	PIN- Bar adjusting
29	81206	1	NUT- Lock, 10-32
30	A69799	1	PUMP- Automatic oil Includes items 31 - 36.
31	80919	2	SCREW- Pan 4-40 x 1/4
32	94619	1	FITTING- Tube
33	59074	2	"O" RING
34	65145	1	GASKET- Cam screw
35	65136	1	SCREW-Cam
36	65142	1	SEAL- Oil pump
37	80567	3	SCREW- Pan 8-32 x 3/4
38	65047A	1	GEAR- Worm
39	65064	1	WASHER- Thrust (Outer)
40	65746B	1	RACE- Inner
41	64124	1	BEARING- Needle
42	A12294	1	SPROCKET & DRUM (std.)
43	67300C	1	PLATE- Guide bar (Inner)
44	67299C	1	PLATE- Guide bar (Outer)
	A69953	1	CLUTCH & PLATE Includes items 45 - 47.
45	683621A	1	CLUTCH
46	69915	1	PLATE- Clutch
47	803612	2	SCREW- Hex hd. 10-32 x 1/2
48	6513115	1	COVER- Drivecase
49	68921	1	DECAL- Drivecase cover
50	81196	2	NUT- Hex, 5/16-18
51	65027	1	WASHER- Thrust (Outer) for rimmed sprocket
52	65985B	1	RACE- Inner
53	63284	1	SPROCKET- Rim type, 3/8 .7 tooth
54	A65987A	1	HUB & DRUM (opt.)
55	65024	1	WASHER- THRUST (Inner)
	588331	1	WASHER- Thrust (Inner)

Ref #	Part Number	Qty	Description
56	65892	3	SHOE- Clutch
57	65217	3	SPRING- Clutch
58	678551	1	PLATE- Clutch (aluminum)
59	80945	1	SCREW- Flat hd. 12-24 x 1
60	81225	1	NUT- Hex 12-24
	65124		Rubber Pad
	65122		Grommet
	65121		Screw, Shoulder
	A652128		Auto. oil pump



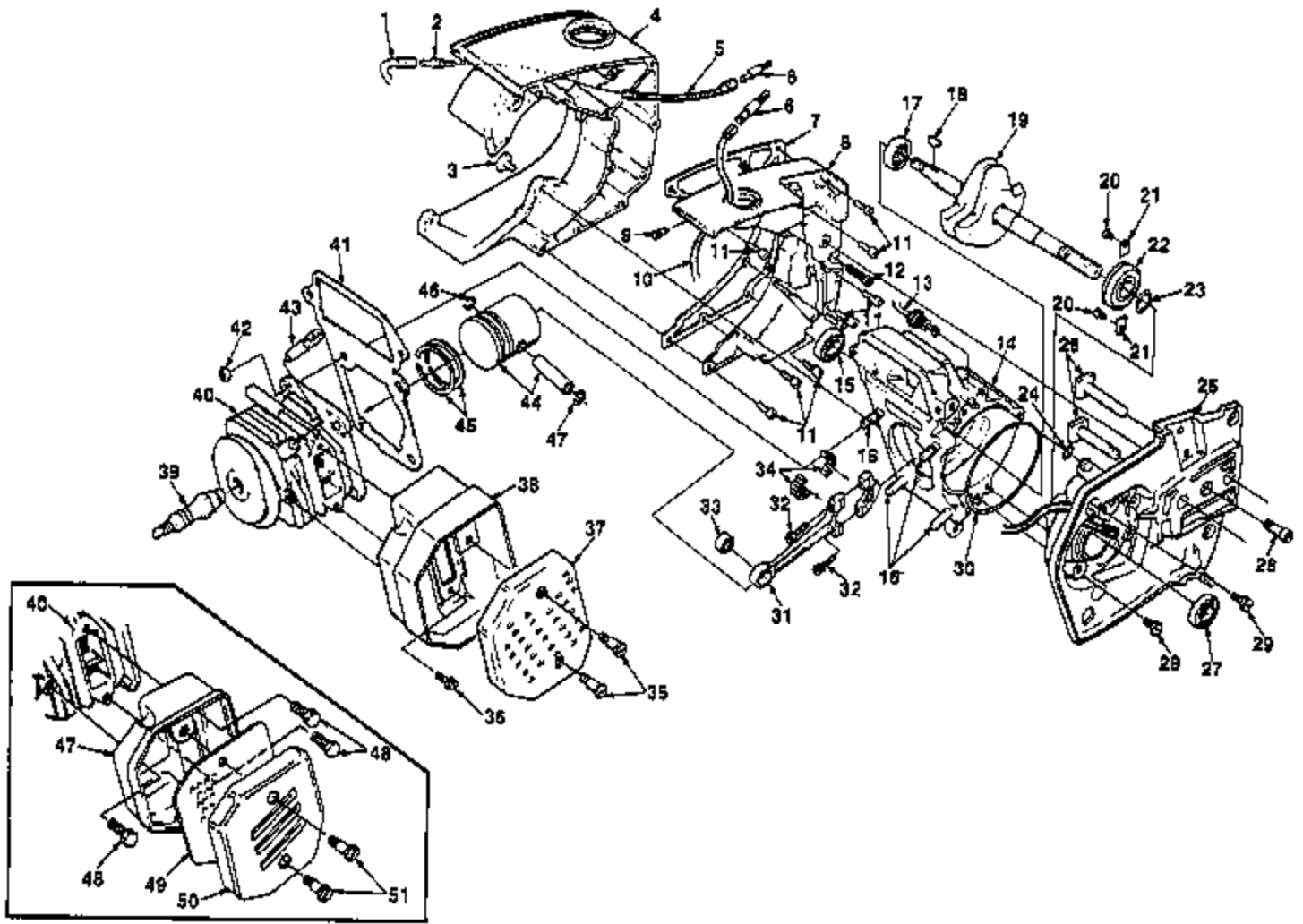

Ref #	Part Number	Qty	Description
1	65137	1	LINE- Oil
2	65138A	1	FITTING- Oil line
3	65321A	3	SCREW- Retaining
4	650377	1	TANK- Fuel & oil
5	9311214	1	LINE- Oil (pick up)
6	A64293	2	FILTER- Oil
7	65046	1	GASKET- Fuel & oil tank
8	A69832A	1	COVER- Fuel & oil tank Includes item 9.
9	69451	1	VALVE- Check
10	9311222	1	LINE- Oil
11	82146	9	SCREW- Fil., 8-32 x 5/8
12	82187	1	SCREW- Fil., 7-32 x 1 7/16
13	A65214	1	LINE- Oil
14	A65202A	1	CRANKCASE Includes items 15 - 17.
15	65019	1	SEAL
16	55871	4	STUD- Cylinder
17	65179	1	BEARING- Roller
18	65126	1	KEY- Woodruff
19	650062	1	CRANKSHAFT
20	70306	2	SCREW- Bearing retaining
21	63905	2	WASHER- Lock
22	65044S	1	BEARING- Ball
23	65045	1	RING- Retaining
24	59074	1	"O" RING
25	A69807A	1	DRIVECASE Includes items 26 - 27.
26	65025	2	BOLT- Guide bar
27	65019	1	SEAL
28	65157A	1	SCREW- Fil., drivecase retainer
29	80676	3	SCREW- Hex. 12-24 x 5/8
30	65127	1	"O" RING
31	A68051	1	ROD- Connecting Includes items 32 - 33.
32	69919	2	SCREW- Cap, hex soc. hd.
33	68512	1	BEARING- Needle
34	A65009	1	BEARING- Needle (Set of 28)
	A68254	1	MUFFLER- Complete (Standard SEZ-AO) Includes items 35 - 38.
35	64133A	2	SCREW- Shoulder
36	80870	3	SCREW- Hex. 10-32 x 3/8
37	682531	1	CAP- Muffler
38	A651522	1	BODY- Muffler
39	65130S	1	SPARK PLUG
40	A69737	1	CYLINDER 1-9/16 dia. Includes item 41.
41	65018	1	GASKET- Cylinder
42	810652	4	NUT- Hex 1/4-28
43	A65184	1	VALVE- Compression release
44	A68487	1	PISTON & PIN Includes items 45 - 46.
45	68508	2	PISTON RING
46	64813	2	RING- Piston pin retaining
	A65275	1	MUFFLER- Louver (Optional) Includes items 47 - 51.
47	A651522	1	BODY- Muffler
48	80870	3	SCREW- Hex, 10-32 x 3/8
49	65067	1	BAFFLE- Muffler
50	650662	1	CAP- Muffler
51	64133A	2	SCREW- Shoulder
	9311222		Oil Line
	69451		Check Valve
	A652001A		Drivecase

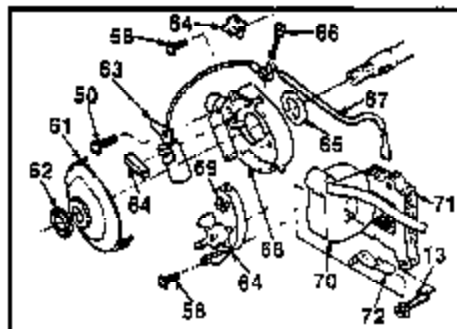
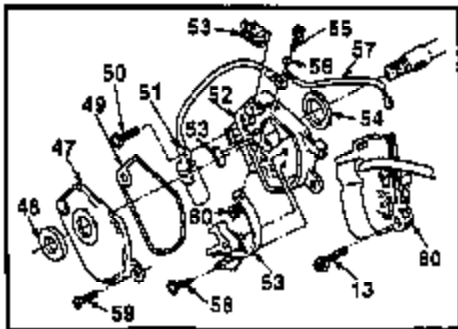
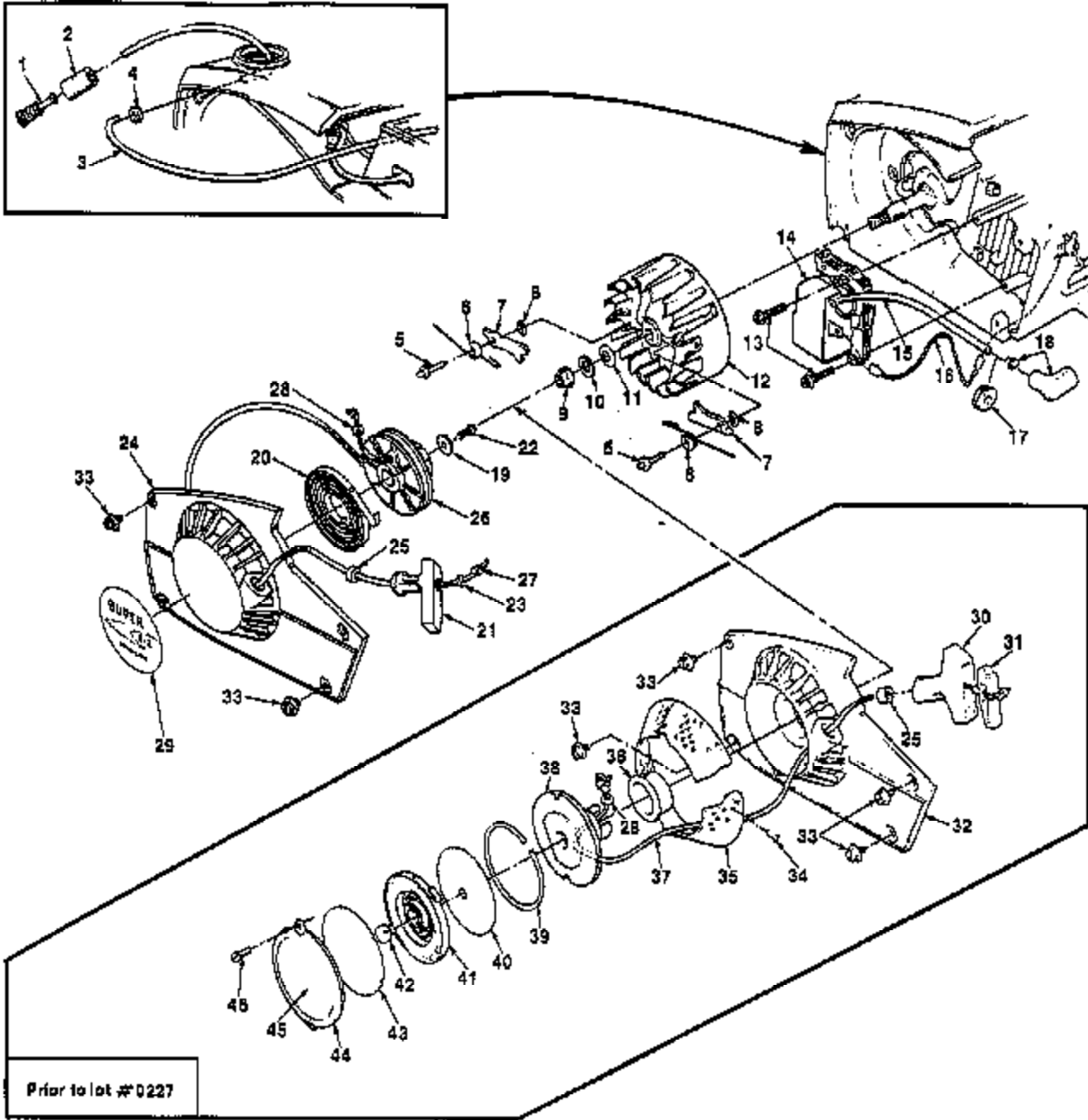

Ref #	Part Number	Qty	Description
1	A69923	1	FILTER- Fuel Includes item 2.
2	64083	1	FILTER- Felt
3	A68053A	1	LINE- Fuel Includes item 4.
4	68046	1	GROMMET
5	65109	2	STUD- Starter pawl
6	65120	2	SPRING- Starter pawl
7	94336	2	PAWL- Starter
8	83046	2	WASHER- Lock #10
9	81117	1	NUT- Hex (5/16 - 24)
10	83002	1	WASHER- Lock
11	840651	1	WASHER- Flat 5/16
12	65288A	1	ROTOR- Magneto (Phelon)
	68701	1	ROTOR- Magneto (Wico)
13	82248	2	SCREW- Hex washer hd 8-32 x 3/4
14	A94111	1	MODULE & CORE (Solid State) Includes item 15.
15	65205	1	LEAD- High tension
16	A63939	1	LEAD- Ground (Point Ignition)
	A94625	1	LEAD- Ground (Solid State)
17	75036	1	GROMMET- Hi tension lead
18	A33055	1	TERMINAL- Spark plug
	A95930	1	KIT- Starter housing Includes items 19 - 29.
19	636061	1	WASHER- Retaining
20	69217	1	SPRING- Rewind
21	70211	1	GRIP- Starter rope
22	70771	1	SCREW- Thrd forming
23	84025	1	WASHER- Flat
24	A958201	1	HOUSING- Starter & bushing Includes item 25.
25	65185	1	BUSHING- Rope
26	94562	1	PULLEY- Starter
27	A93874A	1	ROPE- Starter #4 34" Includes item 28.
28	93862	1	WASHER
29	121922	1	DECAL
30	A69962B	1	GRIP- Starter rope Includes item 31.
31	70018A	1	INSERT- Rope retaining
32			HOUSING- Rewind starter When new housing is required, use A-95930 Conversion Kit. Complete Magneto must be Wico or Phelon. Phelon and Wico parts are not individually interchangeable.
33	80704	4	SCREW- Hex. 10-32 x 5/8
34	67191	3	STUD- Drive #2
35	65189	1	SCREEN- Air inlet
36	68244	1	BUSHING- Starter cup
37	A93876	1	ROPE- Starter 42" (#4)
	93862	1	WASHER- Flat (See Index #28)
38	A65170	1	PULLEY & CUP- Starter
39	65125	1	RING- Shield retaining
40	65114	1	SHIELD- Spring (Outer)
41	65107	1	SPRING- Rewind
42	65102	1	LOCK- Spring
43	65113	1	SHIELD- Spring (Inner)
44	650952	1	COVER- Rewind starter
45	68920	1	DECAL- Starter cover
46	80577	2	SCREW- Pan 8-32 x 3/8
47	A69507	1	COVER- Breaker box (Point ignition) Includes Ref. #48 and 49.
48	687731	1	SEAL- Breaker box cover (Wico)
49	69512	1	GASKET- Breaker box cover (Wico)

Ref #	Part Number	Qty	Description
50	80630	1	SCREW- Pan 6-32 x 1/2
51	68711	1	CONDENSER (Point Ignition) (Wico)
52	69508	1	BOX- Breaker (Point Ignition) (Wico)
53	A68710	1	POINTS- Breaker (Point Ignition) (Wico) Includes item 54.
54	68705	1	SEAL- Felt (Wico)
	28028	AR	WASHER- Thrust (Wico) (Not shown)
	28008	1	LOCK- Breaker arm (Wico) (Not shown)
55	68700	1	SCREW- Hex 6-32 x 1/2 (Point Ignition) (Wico)
56	830041	1	WASHER- Lock #6
57	68712	1	LEAD GROUP- Primary (Point Ignition) (Wico)
58	80571	2	SCREW- Pan 6-32 x 3/8
59	68715	2	SCREW- Cover mounting (Point Ignition) (Wico)
60	68716	1	COIL & CORE- (Point Ignition) (Wico)
61	A65210A	1	COVER- Breaker box (Point Ignition)
62	65211	1	SEAL- Breaker box cover (Phelon)
63	65286	1	CONDENSER- (Point Ignition) (Phelon)
64	A65203A	1	POINTS- Breaker (Point Ignition)
65	65209	1	SEAL- Breaker box (Phelon)
66	68700	1	SCREW- Hex. 6-32 x 7/16 (Phelon)
67	65291	1	LEAD GROUP- Primary (Point Ignition)
68	65206A	1	BOX- Breaker (Point Ignition) (Phelon)
69	65207	1	NUT (Point Ignition)
70	68256	1	COIL- Ignition (Point Ignition)
71	68255	1	CORE- Coil (Point Ignition) (Phelon)
72	68257	1	RETAINER- Coil
	A63920		Filter
	64182		Washer
	65108		Starter Pawl

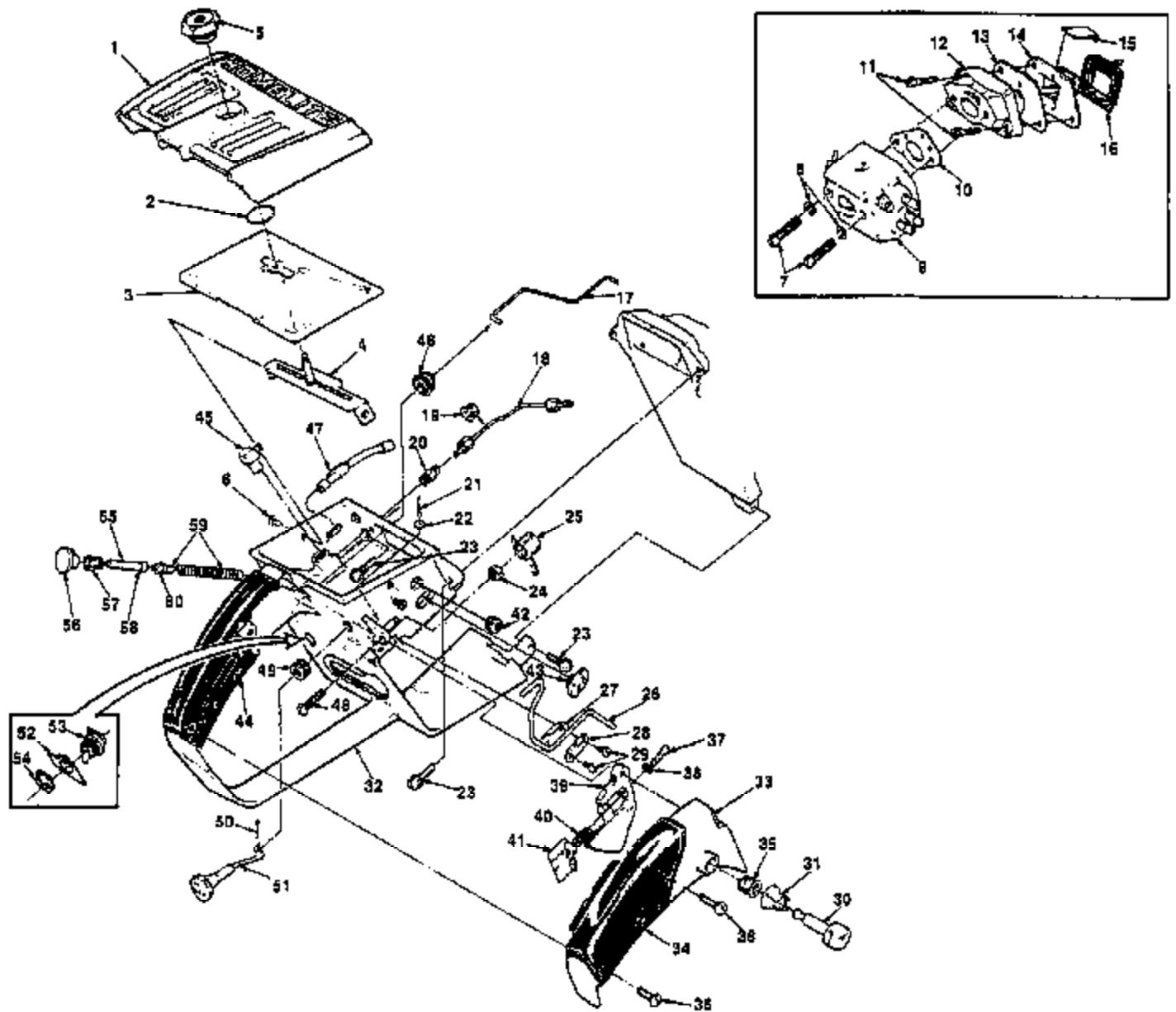

Ref #	Part Number	Qty	Description
1	94271	1	COVER- Air filter
2	58319A	1	RING- Retaining
3	A65178	1	FILTER ELEMENT- Air
4	A95346	1	BRACKET- Air filter cover Includes items 5 - 6.
5	A65272	1	NUT- Cover mounting (1/4-28)
6	95922	2	SCREW- Pan, 8-32 x 3/8
7	82165	2	SCREW- Hex, 10-32 x 1 5/8
8	83046	2	WASHER- Lock #10
9	A68415B	1	CARBURETOR- (HDC-64)
10	65016	1	GASKET- Carburetor
11	64349A	3	SCREW- Shoulder
12	A651541A	1	MANIFOLD- Intake
13	65014A	1	GASKET- Reed valve seat
14	65010	1	SEAT- Reed valve
15	65012A	4	REED- Valve
16	65011A	1	RETAINER- Reed valve
17	65056	1	ROD- Throttle
18	A65214	1	LINE- Oil
	25302	1	NUT- Compression
19	65085	1	GROMMET- Oil line
20	A65077	1	VALVE- Check (outlet)
21	86301	1	PIN- Cotter, 1/16 x 1/2
22	63290	1	WASHER- Felt
23	80676	3	SCREW- Hex, 12-24 x 5/8
24	810101	1	NUT- hex, 10-32
25	65174	1	SPRING- Release valve
26	65173	1	LEVER- Release
27	65092	1	PLATE- Lever
28	65093	1	CLAMP- Lever
29	80571	2	SCREW- Pan 6-32 x 3/8
30	65171A	1	PIN- Trigger latch
31	64677	1	SPRING- Throttle latch
32	A68267B	1	HANDLE- Throttle Includes items 33 - 46.
33	688522	1	COVER- Throttle handle
34	68759	1	GRIP- Throttle handle cover
35	67752	1	BUSHING
36	80560	2	SCREW- Pan, 8-32 x 1/2
37	82198	1	SCREW- Pan 6-40 x 1
38	65260	1	"O" RING
39	65031A	1	TRIGGER- Throttle
40	65188	1	SPRING- Throttle stop
41	65147A	1	STOP- Throttle adjustment
42	68197	1	GROMMET- Idle adjusting
43	68196	1	GROMMET- "Hi-Lo"
	A68053A	1	LINE- Fuel (Shown on Starter and Ignition diagram)
	68046	1	GROMMET (See Starter and Ignition diagram)
44	68770	1	GRIP- Throttle handle
45	A65076	1	VALVE- Check (inlet) 90°
46	67634	1	BOOT- Throttle rod
47	65137	1	LINE- Oil
48	80040	1	SCREW- Round hd., 10-32 x 7/8
49	64862	1	GROMMET- Choke
50	86324	1	PIN- Cotter, 1/32 x 1/2
51	650721	1	ROD- Choke
52	70834	1	PLATE- "On-Off"
53	A63938	1	SWITCH- Grounding Includes item 54.
54	72084A1	1	NUT- Lock
55	A68061A	1	PLUNGER- Oil pump Includes items 56 - 60.

Ref #	Part Number	Qty	Description
56	65084	1	BUTTON- Oil pump
57	65082	1	NUT- Plunger
58	59074	1	"O" RING
59	A67235A	1	PLUNGER- Pump Includes item 60.
60	58406	1	"O" RING



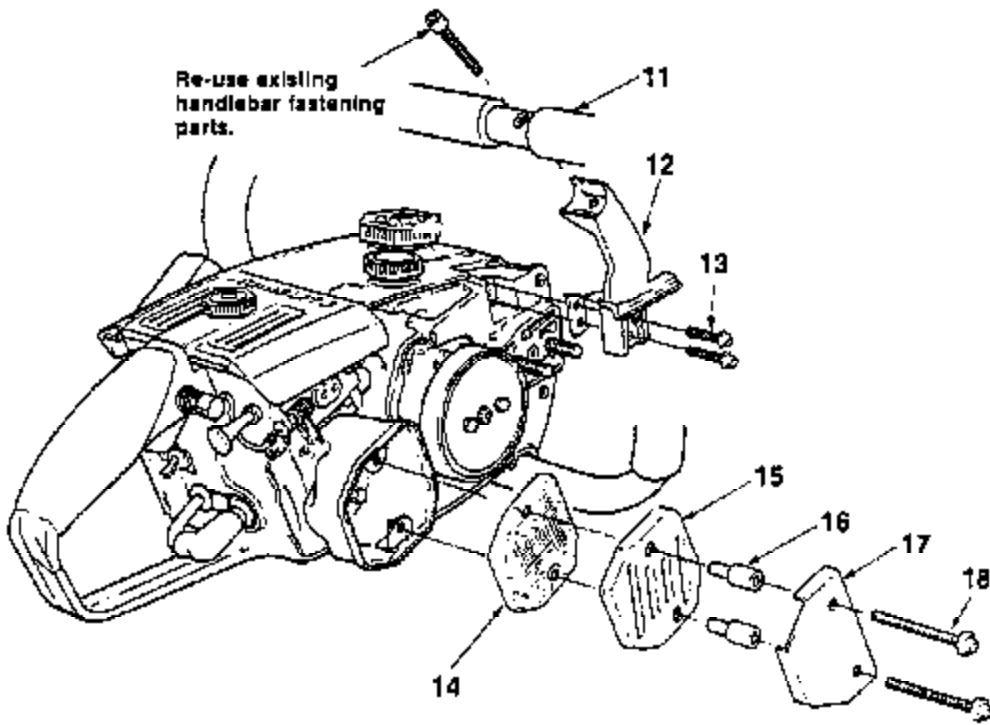
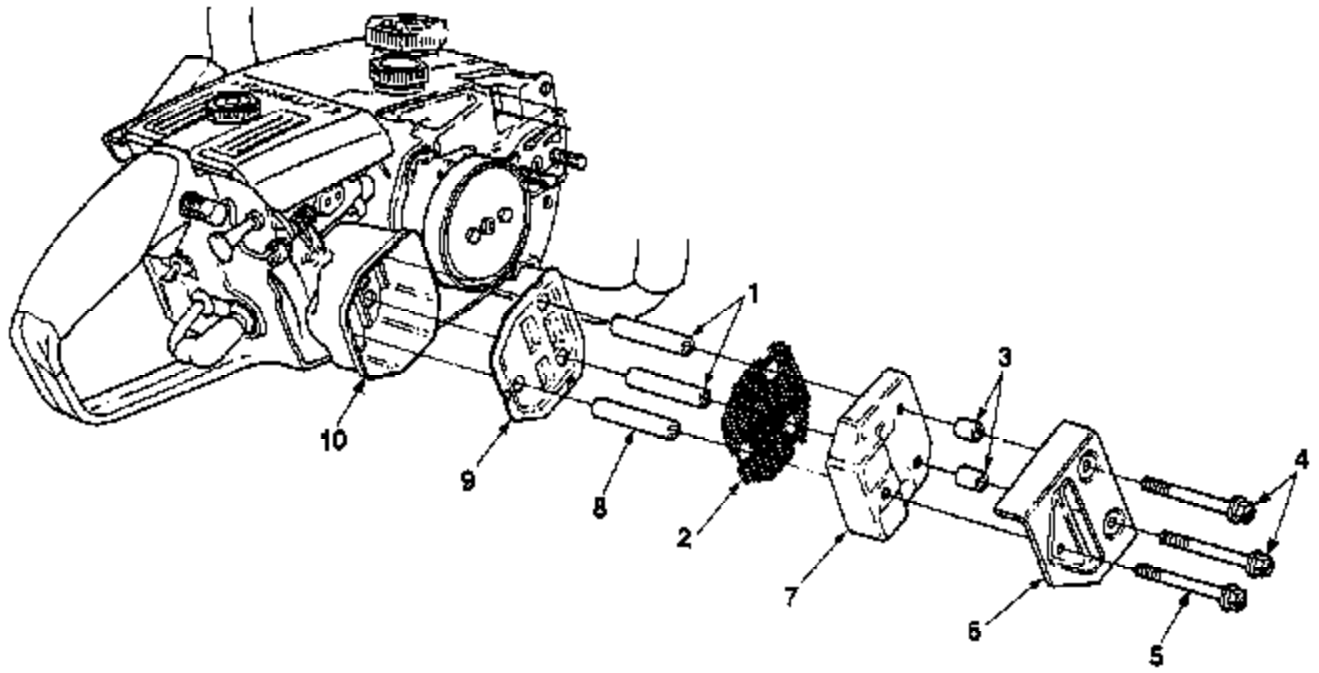

Ref #	Part Number	Qty	Description
1	9529403	2	SPACER- Split 2"
2	95313	1	SCREEN- Muffler
3	9529402	2	SPACER- Split 5/16"
4	95316	2	SCREW- Mach. hex hd. (10-32 x 2 7/8)
5	95315	1	SCREW- Mach. hex hd. (10-32 x 2 5/8")
6	95298	1	DEFLECTOR- Muffler
7	95281	1	CAP- Muffler
8	9529404	1	SPACER- Split 2 1/8"
9	95312	1	BAFFLE- Muffler
10	A651523	1	MUFFLER- Body
	A94118	1	KIT- Muffler temperature Includes items 11 - 18.
11	A684693	1	HANDLE BAR
12	A70303	1	BRACKET- Handle bar Includes item 13.
13	80704	2	SCREW- (#10-32 x .625)
14	DA65256A	1	ARRESTOR- Spark
15	94098	1	CAP- Muffler
16	94100	2	SPACER- Muffler
17	94092	1	SHIELD- Muffler
18	82353	2	SCREW- Hex washer (10-32 x 1.5)